

F · S · T[®]

FINE SCIENCE TOOLS



FINE SURGICAL INSTRUMENTS FOR RESEARCH™

2018

BESTELLINFORMATION ORDERING INFORMATION



TELEPHONE

+49 (0) 62 21 - 90 50 50
Weekdays from 8:30 am to 5 pm (CET)

Please see the last page of the catalog for information on our Terms of Sale and Payment.



FAX

+49 (0) 62 21 - 90 50 590



MAIL

Fine Science Tools GmbH
Vangerowstraße 14
69115 Heidelberg
Germany



ORDERS

europa@finescience.de



TECHNICAL SUPPORT

support@finescience.de



ORDER ONLINE

finescience.de

OUR NEW PRODUCTS

Ceramic Coated Spring Scissors

Page 7



Dowell Scissors

Page 9



Castroviejo Spring Scissors Titanium Ceramic Coated

Page 10



Extra Fine Bonn Scissors

Page 15



Bonn Scissors

Page 15



Tungsten Carbide Mini Lister Scissors

Page 31



Diamond Knives

Page 53



Fine Forceps Mirror Finish

Page 73



Fine Forceps Broad Shanks

Page 73



Fine Forceps Self-Closing

Page 73



Silk Suture Thread

Page 117



Nylon Monofilament Suture Thread

Page 117



Alm Retractor with Wire Teeth

Page 125



Mini-Colibri Retractor

Page 123



Double Tip Protectors Assorted Pack

Page 147



Silicone Mat

Page 151

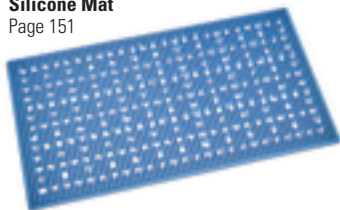

Plastic Sterilization Containers – 3 sizes

Page 153

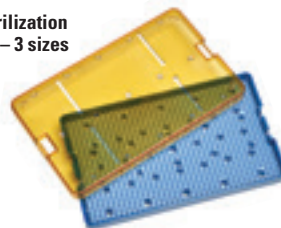

Look for this symbol:



Letter from the Chairman of the Board

Dear customers,

At Fine Science Tools, we value the work and accomplishments of the research community for your successes in the advancement of science. Your commitment and dedication inspires us to continue our focus in supplying you with a vast selection of the finest surgical instruments available worldwide.

By working closely with the world's premier manufacturers, we ensure that you have the most innovative and highest quality surgical instruments to choose from. Our products are designed and crafted to impeccable standards, allowing us to provide our 100% satisfaction guarantee—if, for any reason, you are not completely satisfied with your purchase, you may return it for a full refund.

Looking forward, we promise our continued commitment to quality in support of your future discoveries. On behalf of myself and our staff worldwide, we thank you once again for your patronage and support.

Sincerely,



Hans Gawenda,
Chairman of the Board



Hans Gawenda
Chairman of the Board



Rob Gawenda
President



Michael Dosch
Chief Executive Officer



| | |
|------------------------------|----------------|
| Scissors | 3 – 35 |
| Spring | 3 – 14 |
| Fine | 15 – 28 |
| Surgical | 29 – 35 |
| Bone Instruments | 36 – 49 |
| Rongeurs | 36 – 39 |
| Cutters | 40 – 47 |
| Other Bone Instruments | 48 |
| Curettes & Chisels | 49 |
| Scalpels & Knives | 50 – 61 |



| | |
|------------------|----------------|
| Forceps | 63 – 97 |
| Dumont | 63 – 72 |
| Moria | 74 |
| S&T | 75, 77 |
| Fine | 73 – 80 |
| Standard | 81 – 91 |
| Hemostats | 92 – 97 |



| | |
|-------------------------------|------------------|
| Probes & Hooks | 99 – 103 |
| Spatulae | 102 – 105 |
| Pins & Holders | 106 – 107 |
| Spoons | 108 |
| Wound Closure | 109 – 121 |
| Needle Holders & Suture | 109 – 119 |
| Staplers, Clips & Applicators | 120 – 121 |
| Retraction | 122 – 129 |
| Vascular Instruments | 130 – 139 |
| Clamps & Occluders | 130 – 134 |
| Dilation & Cannulation | 136 – 139 |



| | |
|--|------------------|
| Animal Accessories | 141 – 143 |
| Feeding Needles | 141 |
| Animal Identification | 142 – 143 |
| Instrument Care & Accessories | 144 – 155 |
| Hot Bead Sterilizer | 149 |
| Instrument Cases | 152 – 155 |
| Surgical Accessories | 156 – 159 |
| Cauterizers | 156 |
| Drill Accessories | 159 |
| Laboratory Accessories | 160 – 171 |
| Tools | 160 – 165 |
| Magnifiers | 166 – 171 |



| | |
|--|------------------|
| Student Quality Instruments | 173 – 179 |
| Quality instruments with the student in mind | |
| Scissors | 173 – 174 |
| Forceps | 175 – 177 |
| Hemostat, Needle Holder, Pin Holder, Scalpel Handle & Retractor | 178 – 179 |

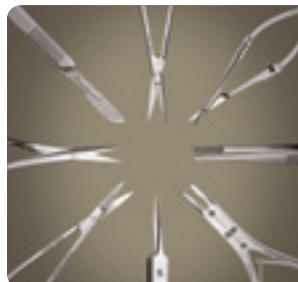

| | |
|------------------------------------|------------------|
| Reference Pages | 181 – 200 |
| Worldwide Locations | 181 |
| Scissors Test | 182 |
| Features and Alloys | 183 |
| Maintenance and Care | 184 – 185 |
| Quality Control | 186 |
| Student Line | 187 |
| Selection | 188 |
| Dumont | 189 |
| Numerical and Alphabetical Indexes | 190 – 199 |
| Additional Information | 200 |



Scissors, Bone Instruments & Scalpels

| | | |
|-------------------|-------|---------|
| Spring Scissors | Pages | 3 – 14 |
| Fine Scissors | Pages | 15 – 28 |
| Surgical Scissors | Pages | 29 – 35 |
| Bone Instruments | Pages | 36 – 49 |
| Scalpels & Knives | Pages | 50 – 61 |



These Vannas-style spring scissors have the smallest blades ever produced. They are ideal where space is restricted and where absolute precision is demanded.



Cutting edge: 2 mm
Tip diameter: 0.05 mm
8 cm



Straight

No. 15000-03
260,50 €



Curved

No. 15000-04
285,00 €

The short taper is ideal for small, precise cuts.



Cutting edge: 2.5 mm
Tip diameter: 0.075 mm
8 cm



Straight

No. 15000-08
167,50 €



Curved

No. 15001-08
175,50 €



Angled to side

No. 15002-08
200,50 €

**MOST
POPULAR**

The long taper is ideal for cutting vessel walls or when a longer cutting edge is needed.



Cutting edge: 3 mm
Tip diameter: 0.05 mm
8 cm



Straight

No. 15000-00
213,50 €



Curved

No. 15000-10
228,50 €

**MOST
POPULAR**

Vannas



Cutting edge: 4 mm
Tip diameter: 0.15 mm
10.5 cm



Straight

No. 15018-10
185,00 €



Curved

No. 15019-10
189,50 €

Vannas-Tübingen



Cutting edge: 5 mm
Tip diameter: 0.1 mm



Straight
8.5 cm

No. 15003-08
190,50 €



Curved
8.5 cm

No. 15004-08
221,50 €



Angled to side
8.5 cm

No. 15008-08
238,00 €

MOST POPULAR



Angled up
9.5 cm

No. 15005-08
225,00 €

Vannas Scissors with Microserrations

Microserrated to minimize slippage.



Cutting edge: 5 mm
Tip diameter: 0.1 mm



Straight

8.5 cm
No. 15070-08
241,50 €



Curved

8.5 cm
No. 15071-08
257,00 €

9.5 cm
No. 15007-08
229,50 €

Miniature Vannas

Hand finished using 40x magnification, these tips are especially useful when incising vessel walls for catheter insertion.



Cutting edge: 5 mm
Tip diameter: 0.1 mm
8 cm



| | |
|--|--|
| Straight | Curved |
| Moria 9600 No. 15396-00 464,50 € | Moria 9601 No. 15396-01 471,00 € |

Titanium Vannas



·TITANIUM·

For more information on Titanium, see page 183.

Cutting edge: 5 mm
Tip diameter: 0.3 mm
9.5 cm

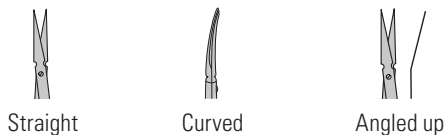

| | | |
|--------------------------|--------------------------|--------------------------|
| Straight | Curved | Angled up |
| No. 15610-08 240,00 € | No. 15615-08 269,00 € | No. 15617-08 275,00 € |

Cohan-Vannas

Long cutting blades for a more controlled cut.



Cutting edge: 6 mm
Tip diameter: 0.125 mm
5.7 cm



| | |
|---|---|
| Straight | Curved |
| Sharp/Sharp No. 15000-02 260,00 € | Sharp/Sharp No. 15000-01 280,00 € |
| Blunt/Blunt No. 15000-12 263,50 € | Blunt/Blunt No. 15000-11 276,00 € |

ToughCut® Spring Scissors



For more information on ToughCut® see page 183.

Cutting edge: 6 mm
Tip diameter: 0.3 mm
12.5 cm

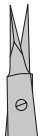

Straight

No. 15124-12
325,00 €

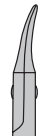

Curved

No. 15123-12
336,00 €

Round Handled Vannas

Round handles allow easy fingertip adjustments.



Cutting edge: 6 mm
Tip diameter: 0.1 mm
12.5 cm



Straight

No. 15400-12
263,50 €



Curved

No. 15401-12
298,50 €

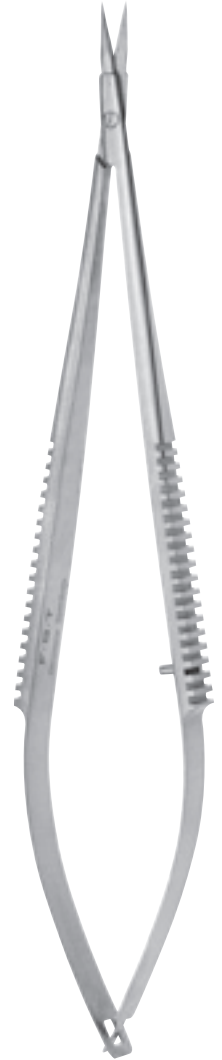

Cutting edge: 6 mm
Tip diameter: 0.225 mm
14 cm



Straight

No. 15020-15
219,50 €

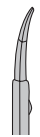

Curved

No. 15021-15
231,00 €

Ceramic Coated Spring Scissors



**NEW
ITEM**

Cutting edge: 7 mm
Tip diameter: 0.1 mm
10 cm

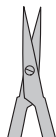

Straight

No. 15750-11
335,00 €



Curved

No. 15751-11
349,00 €

Vannas-Wolff



Moria

Cutting edge: 7 mm
Tip diameter: 0.15 mm
10 cm



Straight

Moria MC52
No. 15370-52
473,00 €



Curved

Moria MC50
No. 15370-50
424,50 €

Ultra long cutting edge
without sacrificing tip width.



Cutting edge: 8 mm
Tip diameter: 0.125 mm
8.5 cm



Straight

No. 15009-08
320,00 €



Cutting edge: 10 mm
Tip diameter: 0.125 mm
10 cm



Angled

No. 15006-09
198,00 €

Same as No. 15006-09 but with a ball tip to prevent piercing of underlying tissue.



Cutting edge: 8 mm
Tip diameter: 1.3 mm Ball
9 cm



Angled

No. 15033-09
216,50 €



Cutting edge: 8 mm
Tip diameter: 0.2 mm
10 cm



Straight
Sharp/Sharp

No. 15024-10
176,50 €



Straight
Blunt/Blunt

No. 15025-10
182,50 €



Curved
Sharp/Sharp

No. 15023-10
196,50 €

Dowell



**NEW
ITEM**

Cutting edge: 10 mm
Tip diameter: 0.1 mm
11.5 cm



Straight

No. 15040-11
234,00 €

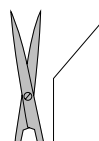

Angled up

No. 15042-11
261,00 €

Noyes



Cutting edge: 14 mm
Tip diameter: 0.275 mm
12 cm



Straight

No. 15012-12
184,50 €



Curved

No. 15011-12
191,50 €

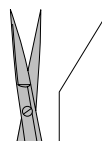

Angled up

No. 15013-12
201,00 €

Tungsten Carbide Noyes

Tungsten carbide cutting edges provide long lasting sharpness.



**TUNGSTEN
CARBIDE**

For more information on tungsten carbide, see page 183.

Tungsten Carbide Cutting Edges

Cutting edge: 14 mm
Tip diameter: 0.275 mm
12 cm



Straight

No. 15514-12
211,50 €

Castroviejo

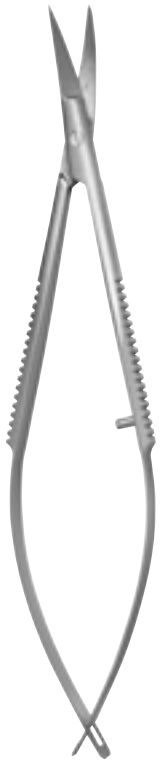

Cutting edge: 10 mm
Tip diameter: 0.255 mm
10 cm



Sharply curved

No. 15017-10
188,50 €

Ceramic Coated Titanium Castroviejo



•TITANIUM•

For more information on
Titanium see page 183.

**NEW
ITEM**

Cutting edge: 5 mm
Tip diameter: 0.2 mm
11 cm



Straight

No. 15650-11
246,00 €



Curved

No. 15651-11
252,00 €

Westcott



Cutting edge: 15 mm
Tip diameter: 0.25 mm
11 cm



Slightly curved

No. 15015-11
184,00 €

Pascheff-Wolff

Very delicate blades.



Cutting edge: 3 mm
Tip diameter: 0.15 mm
10.5 cm



Angled

Moria MC19/B
No. 15371-92
383,50 €

Wecker



Cutting edge: 4 mm
Tip diameter: 0.225 mm
11 cm

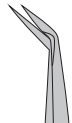

Angled

No. 15010-11
196,50 €



Straight

No. 15028-18
176,00 €



Curved

No. 15027-18
166,50 €



Trident II

A re-release of a popular spring scissors now with a new innovative design for a better feel.



Cutting edge: 8 mm
Tip diameter: 0.2 mm
8 cm



Straight

No. 15110-08
262,50 €



Angled

No. 15111-08
172,00 €

EVO Spring Scissors

These evolutionary ergonomic instruments are lighter than titanium but still have all the benefits of stainless steel. The fully fenestrated spring body has a stability rod to provide balance in your hand.



Cutting edge: 6 mm
Tip diameter: 0.05 mm
15 cm



Straight

No. 15800-00
409,00 €



Curved

No. 15800-01
442,00 €

For the Finest Microdissection

The finest blades on spring scissors. Designed for ophthalmic surgery (vitrectomy). The spring handles are made of ribbed plastic to ensure a solid grip. **Autoclavable.**



Cutting edge: 2.5 mm
Tip diameter: 0.175 mm
14.5 cm



200% of actual size

Straight
Microserrations to minimize slippage.

No. 15030-14
361,00 €



200% of actual size

Angled to side

No. 15031-14
358,50 €



14 cm



200% of actual size

Straight
Cutting edge: 2.2 mm
Tip diameter: 0.15 mm

No. 15036-14
601,00 €



200% of actual size

Angled 90°
Cutting edge: 1 mm
Tip diameter: 0.1 mm

No. 15037-14
622,00 €

Ultra Fine Clipper Scissors II

For microscopic dissections of soft and mucous tissue. The minute fineness of the blades allows clear visualization of the tissue being dissected.



Uses:

- Removing sheath of ganglia to access neurons in aplysia.
- Cutting single nerve axons in aplysia, mollusk and snail.
- Stripping fascia off arteries and muscles.
- Ultra fine brain tissue dissection.
- Cutting of minute fiber optic strands.

Blade shape: Triangular
Blade thickness: 0.1 mm
Tip thickness: 0.05-0.08 mm
Cutting edge: 2.5 mm
10 cm

No. 15300-00
204,00 €

Biemer Scissors

These scissors are designed to securely cut vessels without slipping.



Cutting edge: 4 mm
8.5 cm

No. 15032-08
213,00 €

Cutting edge: 2 mm
13 cm

No. 15032-13
255,50 €

Extra Fine Bonn

Our finest iris scissors, best suited for microdissection under high magnification.



Straight
8.5 cm



Curved
8.5 cm

Sharp/Sharp
No. 14084-08
66,50 €

Sharp/Sharp
No. 14085-08
69,50 €

MOST POPULAR



Sharp/Blunt
No. 14083-08
62,50 €

NEW ITEM

Bonn



NEW ITEM

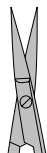

Straight
Sharp/Sharp
9 cm

No. 14184-09
89,00 €



Curved
Sharp/Sharp
9 cm

No. 14185-09
97,00 €

ToughCut® Bonn-Strabismus

A fusion of two light and delicate iris scissors with ToughCut cutting edges.



TOUGH CUT

For more information on ToughCut® see page 183.

ToughCut

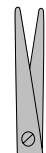

Straight
Blunt/Blunt
9 cm

No. 14084-09
91,50 €



Curved
Blunt/Blunt
9 cm

No. 14085-09
97,50 €

Hardened Fine Iris Scissors

These scissors have undergone an extra vacuum hardening process that extends the life of their cutting edges. They have an anti-reflective finish to reduce glare.

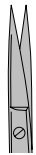

Straight
Sharp/Sharp

8.5 cm
No. 14090-09
55,00 €

**MOST
POPULAR**

11 cm
No. 14090-11
61,50 €



Curved
Sharp/Sharp

8.5 cm
No. 14091-09
64,50 €

11 cm
No. 14091-11
64,00 €

Fine Iris Scissors

Made from Martensitic stainless steel, combined with Molybdenum and Vanadium.



Straight
Sharp/Sharp
10.5 cm

No. 14094-11
64,50 €



Curved
Sharp/Sharp
10.5 cm

No. 14095-11
70,00 €

Delicate pattern.



Straight
Sharp/Sharp

9 cm
No. 14060-09
46,50 €

10.5 cm
No. 14060-10
47,50 €

11.5 cm
No. 14060-11
48,50 €



Curved
Sharp/Sharp

9 cm
No. 14061-09
49,00 €

10.5 cm
No. 14061-10
50,00 €

11.5 cm
No. 14061-11
51,00 €

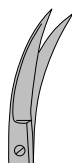

Curved to side
Sharp/Sharp

9 cm
No. 14062-09
63,50 €

10.5 cm
No. 14062-10
64,50 €

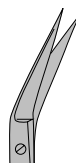

Angled to side
Sharp/Sharp

9 cm
No. 14063-09
62,00 €

11.5 cm
No. 14063-11
59,00 €



Straight
Sharp/Sharp

**LEFT
HANDED** 

10.5 cm

No. 14160-10
78,50 €



Curved
Sharp/Sharp

**LEFT
HANDED** 

10.5 cm

No. 14161-10
81,50 €



Moria

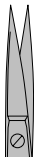

Straight
Sharp/Sharp
10.5 cm

Moria 4877
No. 14370-22
97,00 €



Shallow curve
Sharp/Sharp
10.5 cm

Moria 4878
No. 14370-23
98,50 €

Extra narrow, delicate pattern. Very slim blades with gentle cutting action.



Side-view showing
extra narrow pattern

Straight
Sharp/Sharp
10.5 cm

No. 14088-10
53,00 €

Wagner

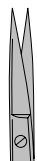

Straight
Sharp/Sharp
Large finger loops
10 cm

No. 14040-10
57,00 €



Curved
Sharp/Sharp
Large finger loops
10 cm

No. 14041-10
63,00 €



Straight
Sharp/Sharp
Non-serrated
12 cm

No. 14068-12
46,50 €



Curved
Sharp/Sharp
Non-serrated
12 cm

No. 14069-12
52,50 €



Straight
Sharp/Sharp
Serrated
12 cm

No. 14070-12
52,00 €



Curved
Sharp/Sharp
Serrated
12 cm

No. 14071-12
58,00 €

ToughCut®



For more information on ToughCut® see page 183.

ToughCut



Straight
Sharp/Sharp

9 cm
No. 14058-09
49,00 €

11.5 cm
No. 14058-11
50,00 €

**MOST
POPULAR**



Curved
Sharp/Sharp

9 cm
No. 14059-09
53,50 €

11.5 cm
No. 14059-11
55,00 €

Tungsten Carbide



For more information on tungsten carbide, see page 183.

Tungsten Carbide Cutting Edges



Straight
Sharp/Sharp

9 cm
No. 14568-09
70,00 €

11.5 cm
No. 14568-12
79,50 €



Curved
Sharp/Sharp

9 cm
No. 14569-09
78,50 €

11.5 cm
No. 14569-12
86,50 €

ToughCut® and Tungsten Carbide

**TOUGH
CUT**

For more information on ToughCut® see page 183.

**TUNGSTEN
CARBIDE**

For more information on tungsten carbide, see page 183.

ToughCut and Tungsten Carbide Cutting Edges



Straight
Sharp/Sharp

9 cm
No. 14558-09
129,00 €

11.5 cm
No. 14558-11
141,50 €



Curved
Sharp/Sharp

9 cm
No. 14559-09
135,50 €

11.5 cm
No. 14559-11
148,50 €

CeramaCut®

These ceramic-coated scissors are the cleanest cutting, longest lasting scissors ever produced. Utilizing the unique properties of a ceramic coating, they will last six times longer than tungsten carbide instruments and cut even better than ToughCut® scissors. The black, corrosion-resistant coating has a non-glare finish.



**CERAMA
CUT**

For more information on CeramaCut®, see page 183.

CeramaCut



Straight
Sharp/Sharp

9 cm
No. 14958-09
238,00 €

11.5 cm
No. 14958-11
234,00 €



Curved
Sharp/Sharp

9 cm
No. 14959-09
236,00 €

11.5 cm
No. 14959-11
241,00 €

Lexer-Baby



Straight
Sharp/Blunt
10 cm

No. 14028-10
45,50 €



Curved
Sharp/Blunt
10 cm

No. 14029-10
50,50 €



Straight
Blunt/Blunt
10 cm

No. 14078-10
43,00 €



Curved
Blunt/Blunt
10 cm

No. 14079-10
49,00 €

Strabismus

Straight
Blunt/Blunt

9 cm
No. 14074-09
49,50 €

11.5 cm
No. 14074-11
54,00 €



Curved
Blunt/Blunt

9 cm
No. 14075-09
57,50 €

11.5 cm
No. 14075-11
61,50 €

Tungsten Carbide Strabismus

**TUNGSTEN
CARBIDE**

For more information on tungsten carbide, see page 183.

Tungsten Carbide Cutting Edges



Straight
Blunt/Blunt

9 cm
No. 14574-09
81,50 €

11 cm
No. 14574-11
84,50 €



Curved
Blunt/Blunt

9 cm
No. 14575-09
85,00 €

11 cm
No. 14575-11
88,50 €

Walton



Slightly curved
Sharp/Sharp

9.5 cm
No. 14077-09
60,00 €

10.5 cm
No. 14077-10
63,50 €

Stevens Tenotomy



Straight
Sharp/Sharp
11 cm

No. 14064-11
55,00 €



Straight
Blunt/Blunt
11 cm

No. 14066-11
50,50 €



Curved
Sharp/Sharp
11 cm

No. 14065-11
60,50 €



Curved
Blunt/Blunt
11 cm

No. 14067-11
56,00 €

ToughCut® LaGrange

One edge is serrated to minimize slippage of tissue during cutting.
Curved handle helps when cutting from an awkward angle.



Side View

ToughCut

**TOUGH
CUT**

For more information on
ToughCut® see page 183.



Curved
Sharp/Sharp
11.5 cm

No. 14173-12
80,00 €

Shea

Transplant scissors with light
and delicate pattern.



Curved
Blunt/Blunt
12 cm

No. 14105-12
64,00 €

Dissector Scissors

Slim blades for cutting tissue.

Similar to 14081-09, but with stronger blades for cutting fine bone.



Angled to side
Sharp/Sharp
Cutting edge: 8 mm
10 cm

No. 14081-09
61,00 €



Angled to side
Sharp/Sharp
Cutting edge: 12 mm
10.5 cm

No. 14082-09
62,50 €

Spencer Ligature

Used for cutting stitches or suture.



Sharp/Sharp
9 cm

No. 14076-09
41,50 €

Bonn Artery

Iris scissors with one ball tip to prevent piercing of underlying tissue.



Delicate

Sharp/1.5 mm Ball
9 cm

No. 14086-09
72,00 €



Sharp/1.5 mm Ball
11.5 cm

No. 14080-11
58,50 €



Blunt/Blunt
11.5 cm

No. 14072-10
57,00 €

Excellent for separating tissue.

See page 8 for artery-style spring scissors.

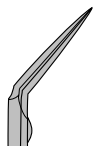
Sharply angled up
Sharp/Sharp
10.5 cm

No. 14037-10
78,50 €

The finger loops can be enlarged to fit almost any size.



Straight
Large finger loops
9.5 cm



Sharp/Sharp
No. 14106-09
55,00 €



Blunt/Blunt
No. 14108-09
50,50 €

Angled to side
Large finger loops
9.5 cm



Sharp/Sharp
No. 14107-09
77,00 €

Kaye

These scissors have semi-sharp outer edges to better facilitate dissection.



Gently curved
Blunt/Blunt
Serrated
Large finger loops
10.5 cm

No. 14171-10
73,50 €

Standard Pattern

Our standard surgical scissors are recognized for these important features:

- Special alloy that gives their cutting edges long life and superior sharpness.
- Excellent feel and handling capability.
- Overall execution that marks them as fine examples of German workmanship.



| Length (cm) | Straight Sharp/Sharp | | Straight Sharp/Blunt | | Straight Blunt/Blunt | |
|-------------|----------------------|---------|----------------------|---------|----------------------|---------|
| 12 | No. 14002-12 | 29,50 € | No. 14001-12 | 28,00 € | No. 14000-12 | 27,00 € |
| 13 | No. 14002-13 | 30,00 € | No. 14001-13 | 28,50 € | No. 14000-13 | 27,50 € |
| 14.5 | No. 14002-14 | 30,50 € | No. 14001-14* | 30,00 € | No. 14000-14 | 28,50 € |
| 16.5 | No. 14002-16 | 33,50 € | No. 14001-16 | 32,50 € | No. 14000-16 | 31,00 € |
| 18.5 | | | No. 14001-18 | 41,00 € | No. 14000-18 | 40,00 € |
| 20 | | | | | No. 14000-20 | 48,00 € |

* Left-handed version also available.



No. 14008-14
119,50 €



| Length (cm) | Curved Sharp/Sharp | | Curved Sharp/Blunt | | Curved Blunt/Blunt | |
|-------------|--------------------|---------|--------------------|---------|--------------------|---------|
| 12 | No. 14005-12 | 35,00 € | No. 14004-12 | 32,50 € | No. 14003-12 | 31,00 € |
| 13 | No. 14005-13 | 33,50 € | No. 14004-13 | 33,00 € | No. 14003-13 | 17,00 € |
| 14.5 | No. 14005-14 | 35,50 € | No. 14004-14 | 35,00 € | No. 14003-14 | 32,50 € |
| 16.5 | No. 14005-16 | 39,00 € | No. 14004-16 | 38,00 € | No. 14003-16 | 36,00 € |
| 18.5 | | | No. 14004-18 | 22,00 € | No. 14003-18 | 20,50 € |
| 20 | | | | | No. 14003-20 | 26,00 € |

ToughCut® Standard Pattern



**TOUGH
CUT**

For more information on ToughCut® see page 183.

ToughCut

Straight
Sharp/Blunt

13 cm
No. 14054-13
58,00 €

17.5 cm
No. 14130-17
61,50 €

Tungsten Carbide Standard Pattern



**TUNGSTEN
CARBIDE**

For more information on tungsten carbide, see page 183.

Tungsten Carbide Cutting Edges



Straight
Sharp/Sharp
14.5 cm

No. 14502-14
100,00 €



Straight
Sharp/Blunt
14.5 cm

No. 14501-14
97,00 €



Curved
Sharp/Sharp
14.5 cm

No. 14505-14
103,00 €



Curved
Sharp/Blunt
14.5 cm

No. 14504-14
101,00 €

Standard Pattern with Serrations



Straight
Sharp/Blunt
Serrated
14 cm

No. 14007-14
45,50 €

Standard Pattern with Large Finger Loops



Straight
Sharp/Blunt
Large finger loops
14.5 cm

No. 14101-14
38,50 €

Tungsten Carbide Mini Lister



TUNGSTEN CARBIDE

For more information on tungsten carbide, see page 183.

Tungsten Carbide Cutting Edges

NEW ITEM

Angled to side
Blunt/Blunt
Smooth
9 cm

No. 14531-09
105,00 €

Lister

Excellent skin cutting scissors. Longer, blunt blade prevents damaging tissue underneath skin without losing the cutting line.



Angled to side
Blunt/Blunt
Serrated
14 cm

No. 14131-14
71,00 €

Metzenbaum Baby

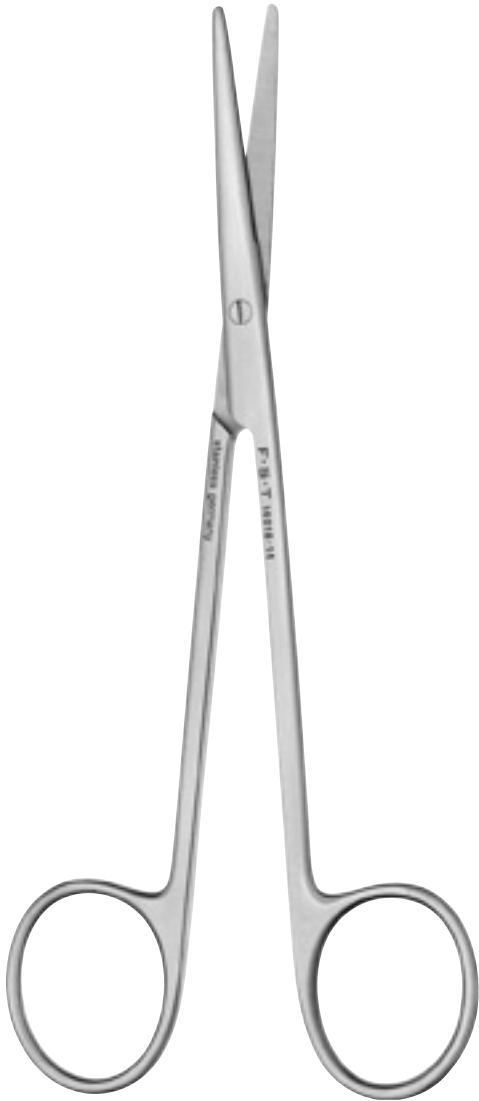

Straight
Blunt/Blunt

13 cm
No. 14018-13
43,50 €

14.5 cm
No. 14018-14
49,50 €

18 cm
No. 14018-18
76,50 €



Curved
Blunt/Blunt

13 cm
No. 14019-13
52,50 €

14.5 cm
No. 14019-14
55,50 €

18 cm
No. 14019-18
40,00 €

Tungsten Carbide Metzenbaum Fino



**TUNGSTEN
CARBIDE**

For more information on tungsten carbide, see page 183.

Tungsten Carbide Cutting Edges



Straight
Blunt/Blunt
Ultra fine tips

14.5 cm
No. 14508-15
130,00 €



Straight
Blunt/Blunt

14.5 cm
No. 14518-14
84,50 €

18 cm
No. 14518-18
87,50 €



Curved
Blunt/Blunt
Ultra fine tips

14.5 cm
No. 14509-15
133,00 €



Curved
Blunt/Blunt

14.5 cm
No. 14519-14
89,50 €

18 cm
No. 14519-18
92,00 €

Metzenbaum

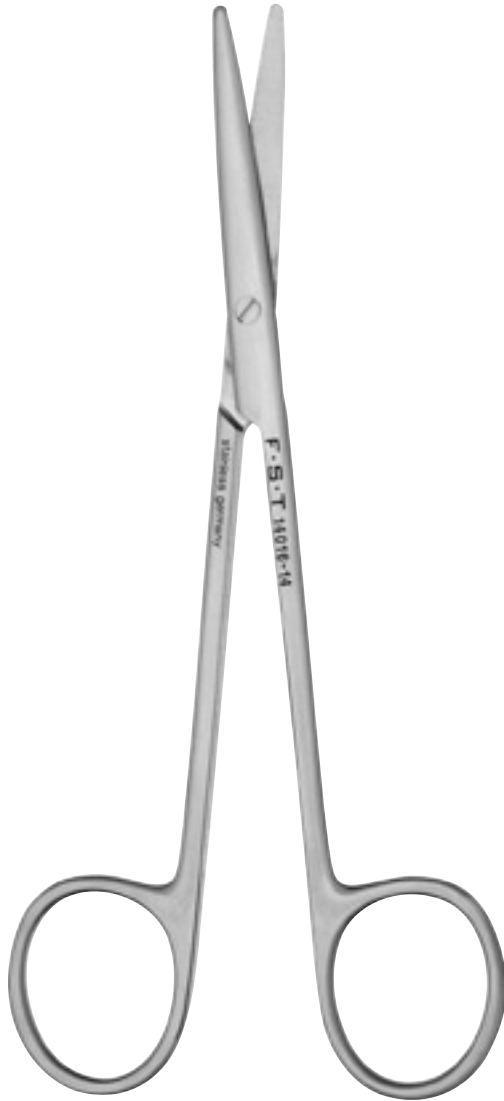

ToughCut® Metzenbaum



For more information on ToughCut® see page 183.

ToughCut

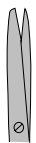

Straight
Sharp/Blunt

14.5 cm
No. 14024-14
50,50 €

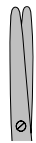

Straight
Blunt/Blunt

14.5 cm
No. 14016-14
44,00 €

18 cm
No. 14016-18
48,50 €



Curved
Blunt/Blunt

14.5 cm
No. 14017-14
48,00 €

18 cm
No. 14017-18
51,00 €



Straight
Blunt/Blunt

14.5 cm
No. 14116-14
47,00 €

18 cm
No. 14116-18
53,00 €



Curved
Blunt/Blunt

14.5 cm
No. 14117-14
53,00 €

18 cm
No. 14117-18
58,00 €

Mayo

ToughCut® Mayo

Tungsten Carbide Mayo



For more information on ToughCut® see page 183.



For more information on tungsten carbide, see page 183.



ToughCut

Tungsten Carbide Cutting Edges



Straight
Blunt/Blunt

15 cm
No. 14010-15
43,50 €

17 cm
No. 14010-17
43,00 €



Curved
Blunt/Blunt

15 cm
No. 14011-15
51,00 €

17 cm
No. 14011-17
20,00 €



Straight
Blunt/Blunt

15 cm
No. 14110-15
56,00 €

17 cm
No. 14110-17
56,50 €



Curved
Blunt/Blunt

15 cm
No. 14111-15
60,00 €

17 cm
No. 14111-17
61,50 €



Straight
Blunt/Blunt

15 cm
No. 14510-15
82,50 €

17 cm
No. 14510-17
86,50 €



Curved
Blunt/Blunt

15 cm
No. 14511-15
87,50 €

17 cm
No. 14511-17
91,00 €



Straight
Blunt/Blunt
ToughCut

15 cm
No. 14512-15
126,50 €

17 cm
No. 14512-17
134,50 €

Mayo-Stille



Straight
Blunt/Blunt

15 cm
No. 14012-15
41,50 €

17 cm
No. 14012-17
45,00 €



Curved
Blunt/Blunt

15 cm
No. 14013-15
45,50 €

17 cm
No. 14013-17
24,00 €

Mayo-Noble



Straight
Blunt/Blunt
16.5 cm

No. 14014-17
69,50 €



Curved
Blunt/Blunt
16.5 cm

No. 14015-17
78,00 €

Decapitation Scissors

Stop guard at tips to prevent slippage.



Straight
Blunt/Blunt
21 cm



No. 14200-21
71,50 €

80% of
actual size

Friedman-Pearson

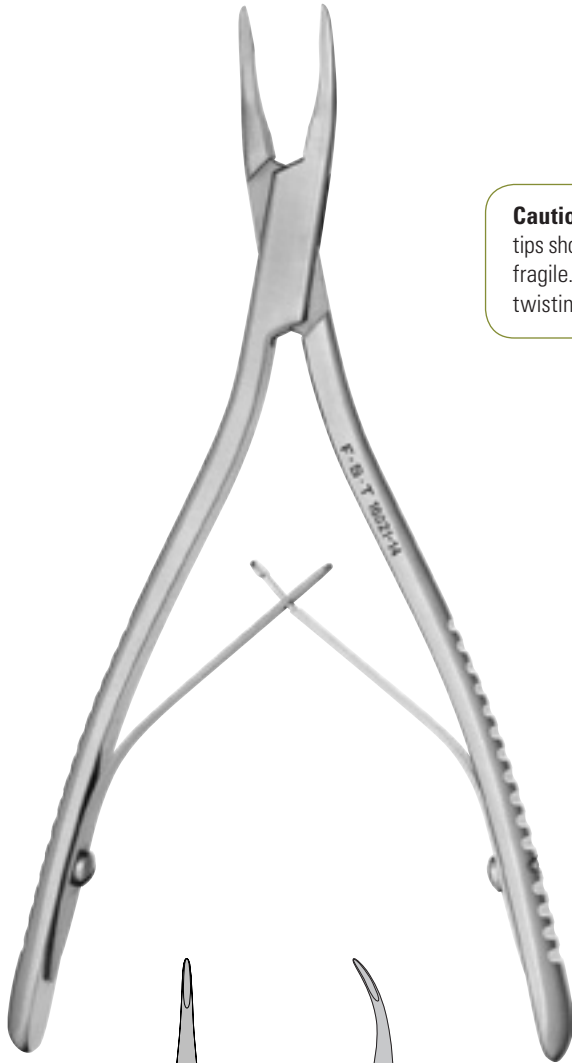
This popular, fine-tipped rongeur is suited for delicate work. The fine-cupped jaws have been designed with a longer and slimmer approach for better visibility.



- | | |
|---|---|
|  |  |
| Straight 14 cm | Curved 14 cm |
| 0.5 mm Cup No. 16220-14 268,00 € | 0.5 mm Cup No. 16221-14 282,50 € |
| 0.7 mm Cup No. 16120-14 252,50 € | 0.7 mm Cup No. 16121-14 262,00 € |
| 1 mm Cup No. 16020-14 234,00 € | 1 mm Cup No. 16021-14 241,50 € |



Cautionary note: The fine rongeur tips shown on this page are extremely fragile. Removal of material with a twisting motion can damage the tips.

MOST POPULAR

Pearson

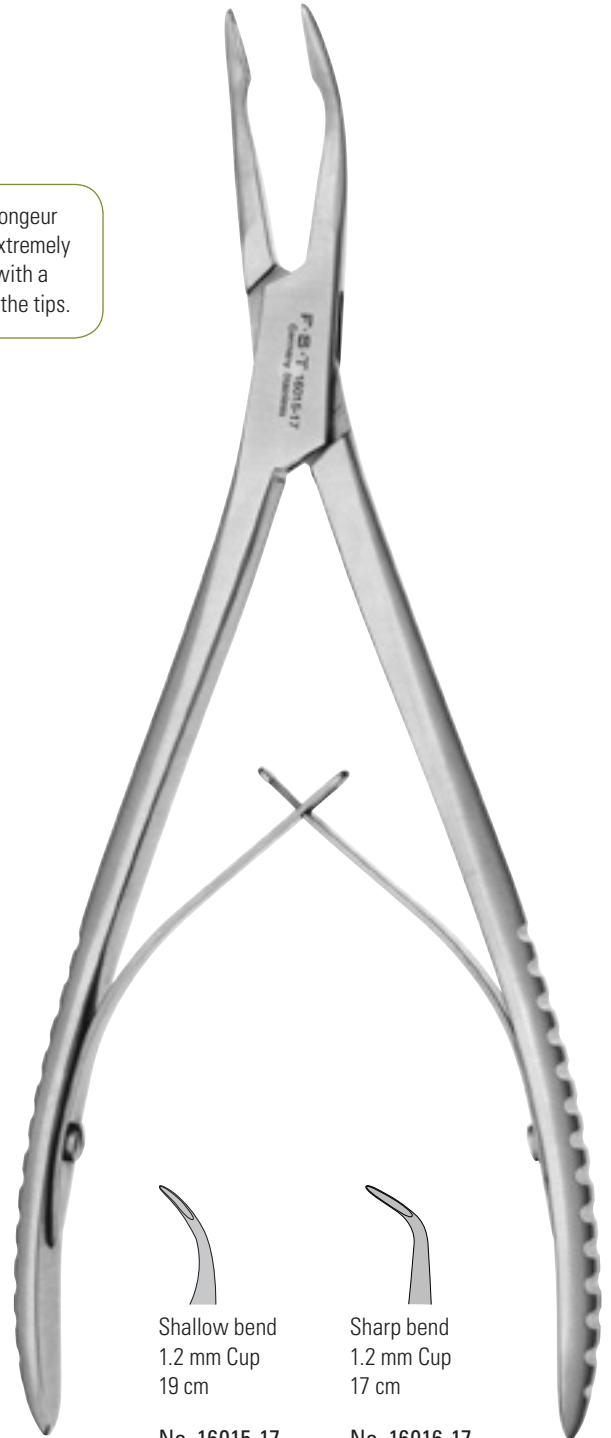
Provides excellent visibility at dissection site due to its extra long and narrow approach to the fine cutting jaws. Especially suitable for larger hands.



- | | |
|---|---|
|  |  |
| Shallow bend 1.2 mm Cup 19 cm | Sharp bend 1.2 mm Cup 17 cm |
| No. 16015-17 231,50 € | No. 16016-17 179,00 € |

Baby-Beyer

Double-action rongeur with strong jaws helps relieve hand strain.



Diameter of this circle determines cup size.

Form an imaginary circle that will fit in the very tip of the instrument and measure its diameter.



Straight
2 mm Cup
15 cm

No. 16023-15
237,50 €

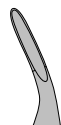

Curved
2 mm Cup
15 cm

No. 16022-15
249,00 €

Beyer

Double-action rongeur with strong jaws helps relieve hand strain.

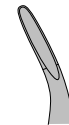

Curved
2.5 mm Cup
18 cm

No. 16002-18
356,00 €

Boynton

A very delicate rongeur for medium to soft materials only.

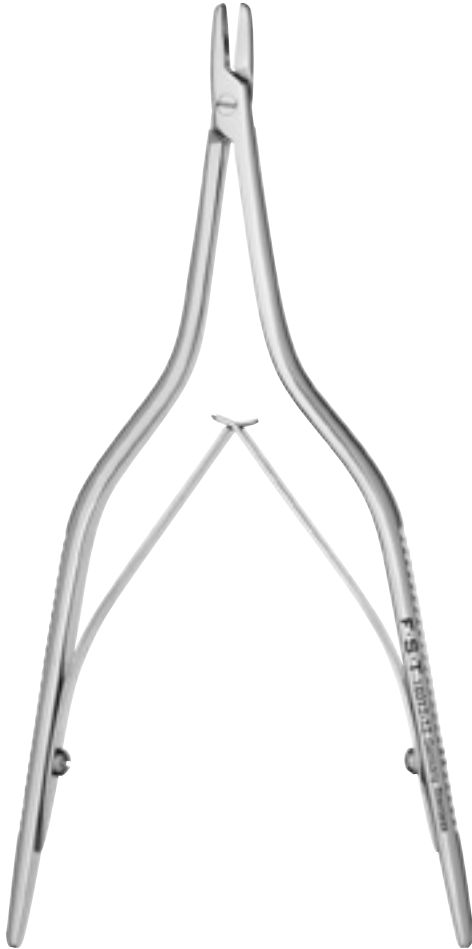

Straight
2 mm Cup
12.5 cm

No. 16012-12
96,00 €

Friedman

Strong and large jaws are ideal for use on the harder, outer regions of the spinal cord. Also can be used to gain access to delicate structures encased in bone.

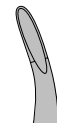

Curved
2.5 mm Cup
13 cm

No. 16000-14
184,00 €

Lempert

Extra fine jaws.

Luer

Diameter of this circle determines cup size.
Form an imaginary circle that will fit in the very tip of the instrument and measure its diameter.

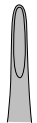

Straight
2.5 mm Cup
16 cm

No. 16004-16
205,00 €

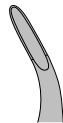

Curved
2.5 mm Cup
16 cm

No. 16005-16
186,00 €



Curved
4 mm Cup
15 cm

No. 16001-15
192,50 €

Bone Trimmers



Curved
Cutting edge: 8 mm
14 cm

No. 16109-14
184,50 €

Cartilage Cutter

Round cutting blades for tissue, cartilage and soft bone.



Curved
Cutting edge: 9 mm
14 cm

No. 16107-14
100,00 €

Dumont #15a Bone Cutter

Cutting edge on both outside and inside bevel. Cuts suture, cartilage, bone and steel wire to 0.06 mm, and copper wire to 0.15 mm.

Not autoclavable.



Hard carbon steel

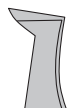

Cutting edge: 10 mm
Jaw opening: 2.5 mm
Hard carbon steel
11.5 cm

No. 11215-01
63,50 €

**Dumont #15a Bone Cutter
Epoxy Coated**

Same structure and functionality as Item No. 11215-01 (left), but with an epoxy coating up to the cutting edge for easier care and maintenance.



Cutting edge: 6 mm
Jaw opening: 2.5 mm
Epoxy coated carbon steel
11.5 cm

No. 11215-02
60,50 €

Bone Forceps

Strong cross-serrated tips for bone crushing and removal.



Angled
Cross serrated
Tip diameter: 1 mm
11.5 cm

No. 16060-11
101,00 €

Malleus Nipper

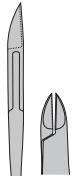

Straight
Serrated
Cutting edge: 9 mm
11 cm

No. 16140-11
91,50 €

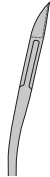

Angled down
Serrated
Cutting edge: 9 mm
11 cm

No. 16141-11
58,50 €

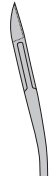

Angled up
Serrated
Cutting edge: 9 mm
11 cm

No. 16142-11
108,00 €

Littauer Bone Cutter



Cutting edge: 15 mm
11 cm
No. 16152-11
74,50 €

Cutting edge: 17 mm
12.5 cm
No. 16152-12
82,50 €

Cutting edge: 19 mm
15 cm
No. 16152-15
87,50 €

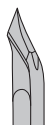
Bone Nipper

Angled
Cutting edge: 5 mm
11 cm

No. 16102-11
82,50 €

Offset Bone Nipper

Strong jaws for cutting tough cartilage.

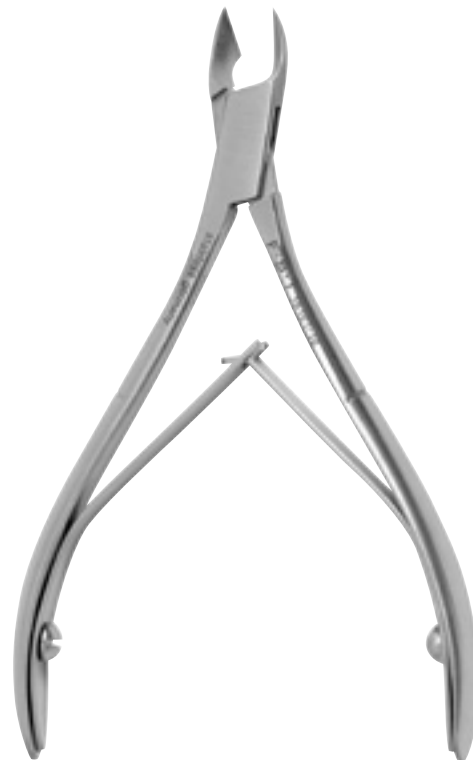

Angled
Cutting edge: 7 mm
10 cm

No. 16101-10
92,00 €

Bone Cutting Spring Scissors



Straight
Cutting edge: 12 mm
13 cm

No. 16144-13
121,50 €

Beebe Bone Scissors

Very strong jaws with sharp points.



**MOST
POPULAR**

Straight
Cutting edge: 15 mm
10 cm

No. 16044-10
32,00 €

Tungsten Carbide Bone Scissors

Strong heavy blades for cutting bone.



**TUNGSTEN
CARBIDE**

For more information on tungsten carbide, see page 183.

Tungsten Carbide Cutting Edges

Straight
Cutting edge: 15 mm
12.5 cm

No. 16030-12
114,00 €

Straight
Cutting edge: 15 mm
16 cm

No. 16030-16
127,50 €

Boehler

Bone splitting cutter with very fine tips and double action joint to relieve strain on your hand.



Angled up 10°
Cutting edge: 18 mm
15 cm

No. 16130-15
312,50 €

Skull Flap Cutter

One tip has a flat and narrow platform which fits between dura and skull. Other tip has sharp cutting edge.



Angled up 15°
Cutting edge: 10 mm
14 cm

No. 16050-15
348,50 €

Cleveland Cutter



Straight

Cutting edge: 14 mm
15 cm
No. 16106-14
118,00 €

Cutting edge: 15 mm
17 cm
No. 16105-16
182,50 €

Liston

Gross anatomy bone cutter.



Straight

Cutting edge: 20 mm
14 cm
No. 16104-14
134,50 €

Cutting edge: 30 mm
20 cm
No. 16104-19
173,50 €

Bone Shears

75% of actual size

Cutting edge: 6.5 cm
24 cm

No. 16150-24
59,50 €

Bone Pliers

To peel back skull flaps.

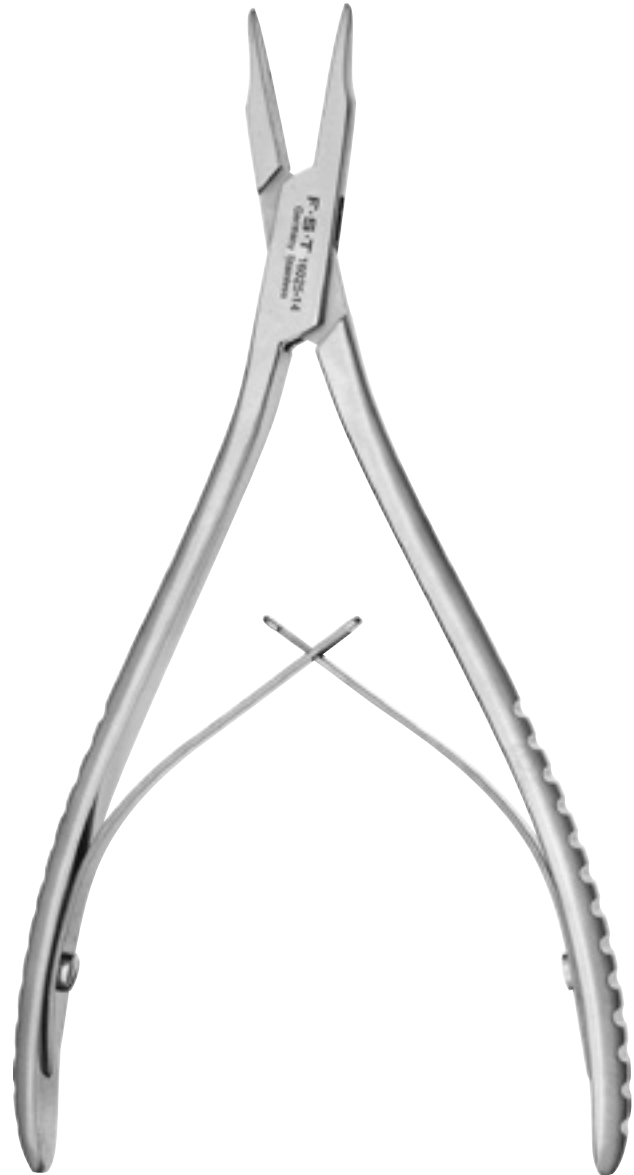

Flat surface
15.5 cm

No. 16025-14
164,00 €

Self-Holding Pin and Bone Screw Forceps

Designed with a serrated tip and grooved cup for a stable and secure grip, these forceps hold pins and screws allowing precise placement at your target area. They are compatible with all Fine Science Tools insect pins, minuten pins and bone screws.



Polished stainless steel
14 cm

No. 26100-00
78,00 €



Miniature Self-Tapping Bone Screws

Used extensively to anchor dental cement to bone, these self-tapping screws have superior holding strength over ordinary machine screws. Stainless steel with fillister flat head.

Shaft diameter: 0.86 mm
Length: 4 mm

Pkg. of 100 screws
No. 19010-10
160,00 €

For pre-drilling use our 0.7 mm burs,
see page 159.

Shaft diameter: 1.19 mm
Length: 4.8 mm

Pkg. of 100 screws
No. 19010-00
87,00 €

For pre-drilling use our 0.9 mm burs,
see page 159.

Bone Wax

A beeswax-based compound for bone hemostasis. Soft, kneadable and ready to use. **Sterile.**



Box of 12 foil packs (2.5 g each)
No. 19009-00
125,50 €

Micro Curette

Curette tips consist of a scoop with sharp edges and are used for scraping or cleaning. They can also be used for separating and transporting, inoculating plates or transferring small amounts of chemicals.

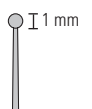
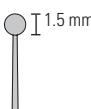
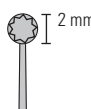

- | | | | |
|---|---|---|---|
|  |  |  |  |
| 13 cm | 13 cm | 13 cm | 12.5 cm |
| No. 10080-05 70,00 € | No. 10081-10 66,00 € | No. 10082-15 66,00 € | No. 10083-20 99,50 € |

Serrations on cutting edge

Delicate Bone Scraper



For scraping tissue without cutting into bone.



- | |
|---|
|  |
| 16.5 cm |
| No. 10075-16 85,00 € |

Austin Chisel

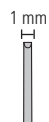

- | | |
|--|---|
|  |  |
| 16 cm | 16 cm |
| No. 10096-16 100,00 € | No. 10097-16 100,00 € |

Dissecting Chisel

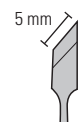

- | |
|---|
|  |
| 12.5 cm |
| No. 10095-12 40,00 € |

Von Graefe Knife

Used for cutting dura.

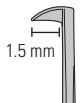

Angled 90°
Cutting edge: 1.5 mm
13 cm

No. 10059-13
75,00 €

One of the most popular dissecting knives with a microfine point. The cutting edge is lance shaped to provide the ideal cutting angle.



Cutting edge: 4 mm
12.5 cm

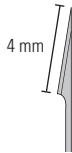

Straight

No. 10055-12
73,00 €

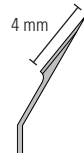

Angled 30°

No. 10056-12
82,50 €

Sichel

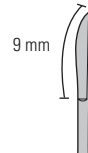

Cutting edge: 9 mm
12 cm

No. 10073-14
64,00 €

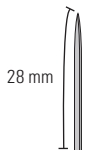

28 mm

Cutting edge: 28 mm
13 cm

No. 10370-13
88,00 €

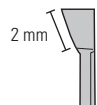

2 mm

Side blade 20°
Cutting edge: 2 mm
15 cm

No. 10058-15
119,00 €

Circle Knife

Sharp cutting edge around tip.

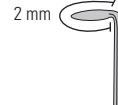

2 mm

Angled 90°
Cutting edge: 2 mm
16 cm

No. 10059-15
103,00 €

Ceramic Blades

Advantages:

- Ceramic edge stays sharp 100 times longer than steel edge
- Rust and corrosion free
- Chemical and acid resistant
- Withstands up to 2400°C (4352°F)
- No electrostatic discharge concerns
- No trace metal contamination
- Fully nonmagnetic
- **Autoclavable**



Handle

12.5 cm
No. 10025-50
7,00 €



Ceramic Blade

45° Cutting Edge
Cutting edge: 8 mm
33 x 6 x 0.5 mm

Pkg. of 5 blades
No. 10025-45
95,00 €

Obsidian Stone Age Scalpels

For applications where extremely fine cuts are required or for studies where trace metals from ordinary scalpel blades cannot be tolerated. These ultra fine cutting edges have been used in human surgical procedures where objectionable scar tissue results from the use of standard scalpels.

The blade is made from obsidian—a type of volcanic glass—which allows a much finer blade than is possible with the conventional steel blade. In some cases this makes the relatively inexpensive obsidian scalpel a suitable substitute for an expensive diamond knife.

Patterned after “stone age” knives which first made their appearance about 18,000 years ago, these modern versions utilize a hard wood dowelling for handles.



Cautionary note:

Obsidian is a very fragile material. Great care should be taken to not exert any lateral pressure on the blade during cutting.

Each blade is hand-fashioned, so sizes, shapes and points will vary. While all the blades will have at least one sharp edge, some will have two.

75% of actual size

Approximate blade length: 6 mm
No. 10110-01
99,00 €

Approximate blade length: 12 mm
No. 10110-03
101,00 €

Diamond Knives

This knife has a gem-quality, neutral diamond blade which is honed to the finest cutting edge possible. The blade is made to an ophthalmic surgical standard and is inspected under 400x magnification. The retractable handle aids in care and storage.

**NEW
ITEM**

Cautionary note:

This blade is extremely fragile and vulnerable to lateral pressure.

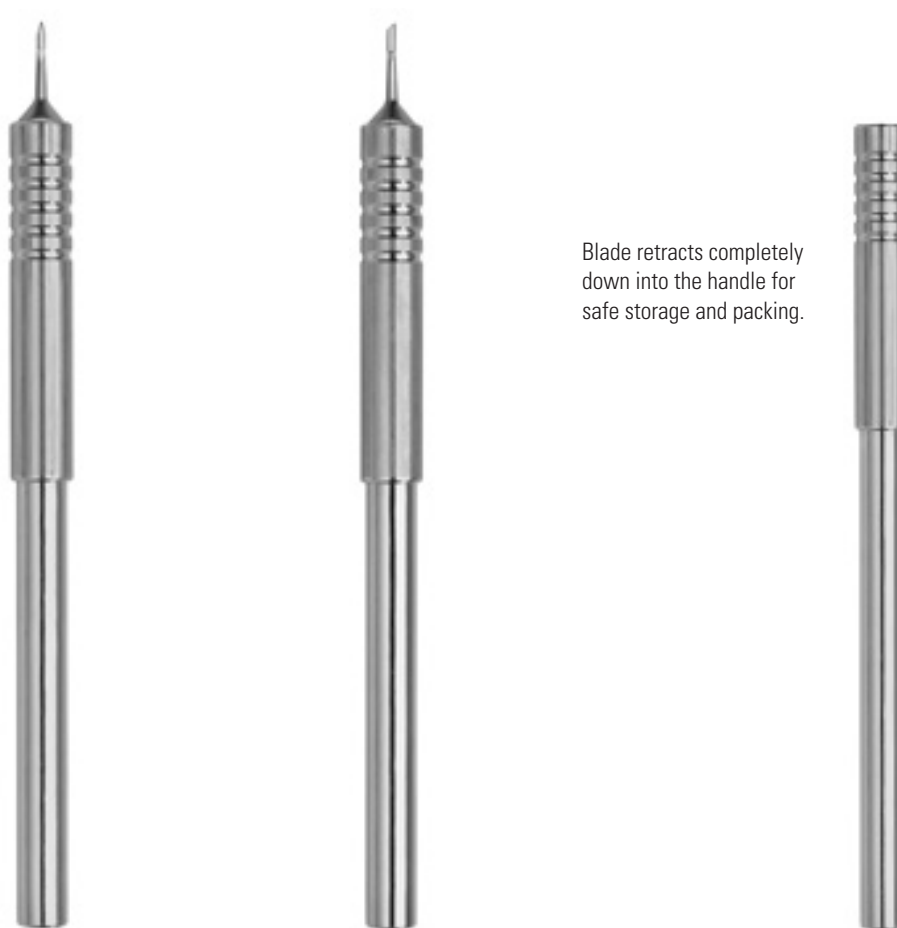

Blade retracts completely down into the handle for safe storage and packing.

Tip thickness: 0.15 mm
Cutting edge: 1 mm
12 cm



Cutting angle: 30°
No. 10100-30
350,00 €



Cutting angle: 45°
No. 10100-45
365,00 €

Gross Anatomy Knives

Handles are made of fiberglass reinforced yellow nylon with a slip resistant surface that allows little chance of bacterial accumulation. The blades are made of German Molybdenum Stainless Steel.

40% of actual size



Dissection knife

Cutting edge: 13 cm
28 cm
No. 10157-13
15,50 €

Cutting edge: 15 cm
30 cm
No. 10157-15
17,00 €

Cutting edge: 18 cm
33 cm
No. 10157-18
20,50 €

40% of actual size



Brain sectioning knife

Cutting edge: 30 cm
45 cm
No. 10152-30
33,00 €

Blade Holders and Breakers



Flat surface

Jaw width: 4 mm
11 cm
No. 10052-11
139,50 €



Surface with concave
and convex jaws

Handle diameter: 5.5 mm
9 cm
No. 10053-09
264,00 €

Handle diameter: 8 mm
13 cm
No. 10053-13
259,50 €

Breakable Carbon Steel Blades

These special, high carbon content blades are the only blades that will break cleanly.



Blade thickness: 0.1 mm

Box of 10 blades
No. 10050-00
12,00 €

Create Your Own Blade

With these blade holders/breakers and our special carbon steel blades, No. 10050-00, you can produce microblades in sizes that meet your own individual needs.

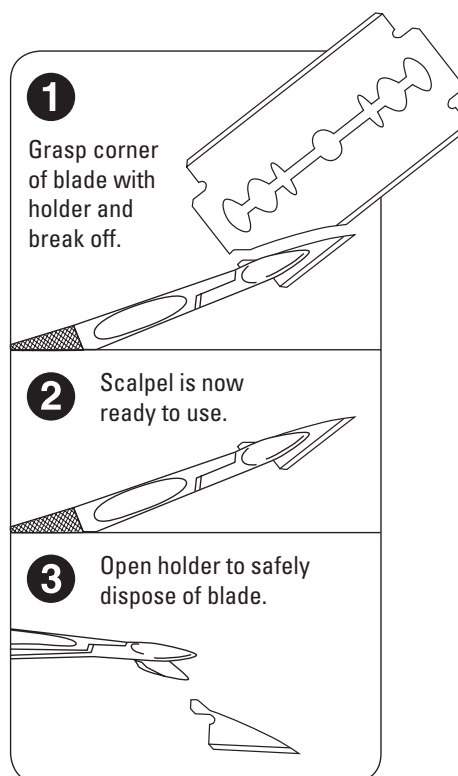

Cold forged from carbon steel and sharpened to eliminate tissue distortion and blade drag. 12.5 cm plastic handle with slip-proof grip. **Sterile.**

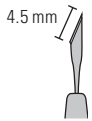

Cutting angle: 22.5°
Tip thickness: 0.15 mm
Cutting edge: 4.5 mm
13.5 cm

No. 10316-14
24,50 €

MOST POPULAR



Cutting angle: 15°
Tip thickness: 0.15 mm
Cutting edge: 5 mm
13 cm

No. 10315-12
22,00 €

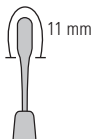

Crescent blade
Tip thickness: 0.20 mm
Cutting edge: 11 mm
14 cm

No. 10317-14
41,50 €



Needle blade
Tip thickness: 0.20 mm
Cutting edge: 4 mm
14.5 cm

No. 10318-14
64,50 €

Interchangeable Carbon Steel Blades



Handle for
Interchangeable
Blades

9.5 cm
No. 10035-00
40,00 €

12.5 cm
No. 10035-12
37,00 €



Angled blade
Carbon steel
Cutting edge: 10 mm

Pkg. of 5 blades
No. 10035-15
28,50 €



Curved blade
Carbon steel
Cutting edge: 10 mm

Pkg. of 5 blades
No. 10035-20
24,00 €



Small flat blade
Carbon steel
Cutting edge: 1.5 mm

Pkg. of 5 blades
No. 10035-05
23,00 €



Large flat blade
Carbon steel
Cutting edge: 2.75 mm

Pkg. of 5 blades
No. 10035-10
23,00 €



Cane blade
Carbon steel
Cutting edge: 12 mm

Pkg. of 5 blades
No. 10035-25
9,00 €



Arc blade
Carbon steel
Cutting edge: 12 mm

Pkg. of 5 blades
No. 10035-30
61,00 €

Scalpel with Plastic Handle #4

For heavy, gross anatomy work.
Molded to fit hand.



#4 Plastic
13.5 cm

No. 10008-13
27,50 €

Standard Scalpel Handle #4 Solid

Especially suitable for large dissections.



#4 Solid
13 cm

No. 10004-13
11,50 €

Blades for #4 Scalpel Handle

The alloy used has a high carbon content which provides a longer lasting edge. Blades come individually wrapped. **Non-sterile.**



Box of 100 blades
No. 10020-00
43,50 €



Box of 100 blades
No. 10021-00
43,50 €



Box of 100 blades
No. 10022-00
43,50 €



Box of 100 blades
No. 10023-00
43,50 €

Standard Scalpel Handle #3 Solid



#3
12 cm

No. 10003-12
11,50 €

**MOST
POPULAR**

Secure Scalpel Handle #3

A safety lock holds the blade securely, and allows simple and safe blade attachment and removal.



#3
12 cm

No. 10003-13
20,00 €

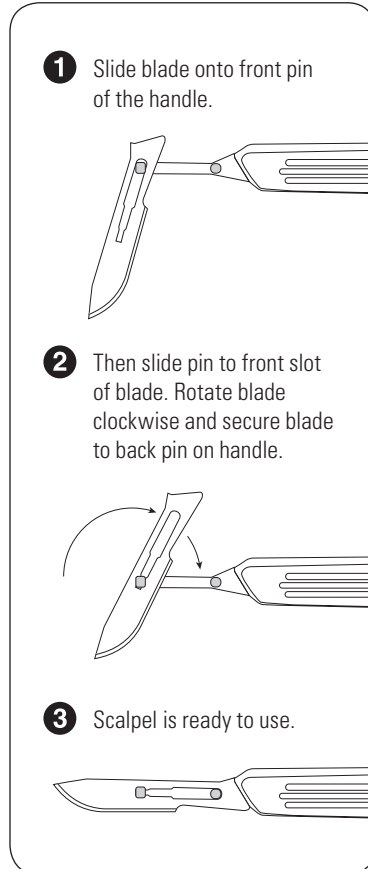

Blades for #3 and #7 Scalpel Handles

The alloy used has a high carbon content which provides a longer lasting edge. Blades come individually wrapped. **Non-sterile.**



Box of 100 blades
No. 10010-00
43,50 €



Box of 100 blades
No. 10011-00
43,50 €

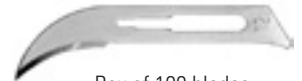

Box of 100 blades
No. 10012-00
43,50 €



Box of 100 blades
No. 10015-00
43,50 €

Short Scalpel Handle #7 Solid



#7 short
12 cm

No. 10007-12
16,00 €

Standard Scalpel Handle #7 Solid



#7 long
16.5 cm

No. 10007-16
18,00 €

Scalpel Blade Remover

For safe removal of scalpel blades, simply insert scalpel with blade into the Scalpel Blade Remover and press the sides together. This will dislodge the blade from handle and hold the blade securely for release.



6.5 cm

No. 10002-00
10,00 €

Scalpel Blade Removal and Disposal Box

This plastic device will remove used scalpel blades safely and retain them for safe disposal. Can be used for blades that fit the #3, #4, #7 and Gross Anatomy handles.

Capacity approximately 80 blades
7.5 x 5 x 2.5 cm

Carton of 10 boxes
No. 10002-50
19,50 €



Your fingers will never come in contact with the blade.

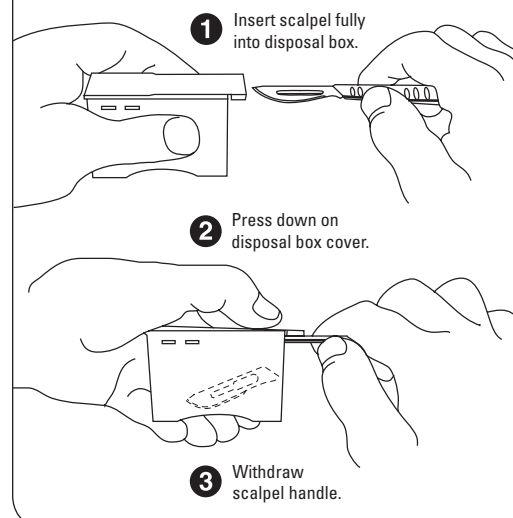

Gross Anatomy Blade and Handle



7.5 cm

Box of 100 blades
No. 10060-00
60,00 €



13 cm

No. 10060-13
13,00 €

Disposable Safety Scalpels

Plastic handle #3 with stainless steel blades. The protective cartridge completely covers the blade for safe, fast, and easy disposal. **Single-use and non-sterile.**

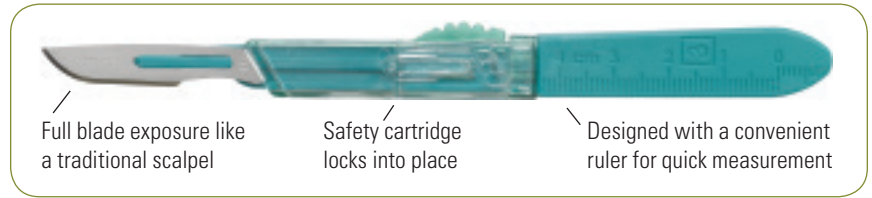

#10 scalpels
Pkg. of 10
No. 10000-10
29,50 €



#11 scalpels
Pkg. of 10
No. 10000-11
31,50 €



#15 scalpels
Pkg. of 10
No. 10000-15
31,50 €



Scalpel shown with safety cartridge closed and locked into place.

Plastic handle with stainless steel blades
14 cm

Safety Scalpel Handle #3 and Blade Cartridges

The Safety Scalpel Handle #3 is compatible with all Safety Scalpel Blades. The handle is reusable and made of Teflon coated stainless steel which provides a non-stick surface. The Blade Cartridges are color-coded with clear windows for easy identification. The protective cartridge completely covers the blade for safe, fast, and easy disposal. **Handle is reusable and autoclavable. Blades are single-use and non-sterile.**

Full blade exposure like a traditional scalpel

Safety cartridge locks into place

Reusable handle can be cleaned and sterilized

Designed with a convenient ruler for quick measurement

Cartridge ejection button adds an external layer of safety

Protective safety cartridge completely covers the blade

Handle and cartridges sold separately.

Handle has same length, weight, shape, center of gravity, and "feel" of a traditional scalpel

Safety Scalpel Handle #3



Teflon coated stainless steel
12.5 cm

No. 10006-12
18,50 €

Safety Scalpel Blade Cartridges



#10 blades
Pkg. of 10
No. 10010-10
30,00 €



#11 blades
Pkg. of 10
No. 10011-10
30,00 €



#15 blades
Pkg. of 10
No. 10015-10
30,00 €



Scalpel blade shown with safety cartridge closed and not attached to handle.

Safety Scalpel Blade Cartridges shown open and attached to handle.
Handle and cartridges sold separately.

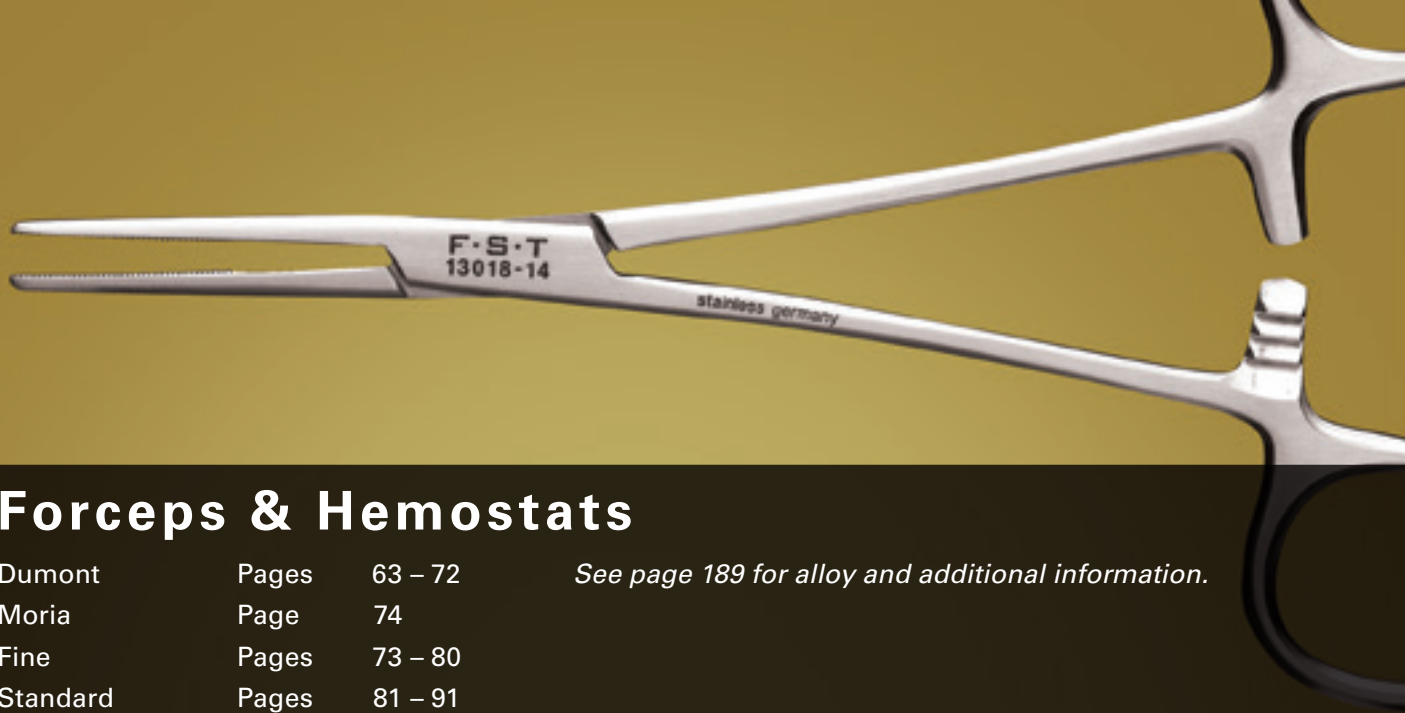

Forceps & Hemostats

| | | | |
|-----------|-------|---------|---|
| Dumont | Pages | 63 – 72 | <i>See page 189 for alloy and additional information.</i> |
| Moria | Page | 74 | |
| Fine | Pages | 73 – 80 | |
| Standard | Pages | 81 – 91 | |
| Hemostats | Pages | 92 – 97 | |

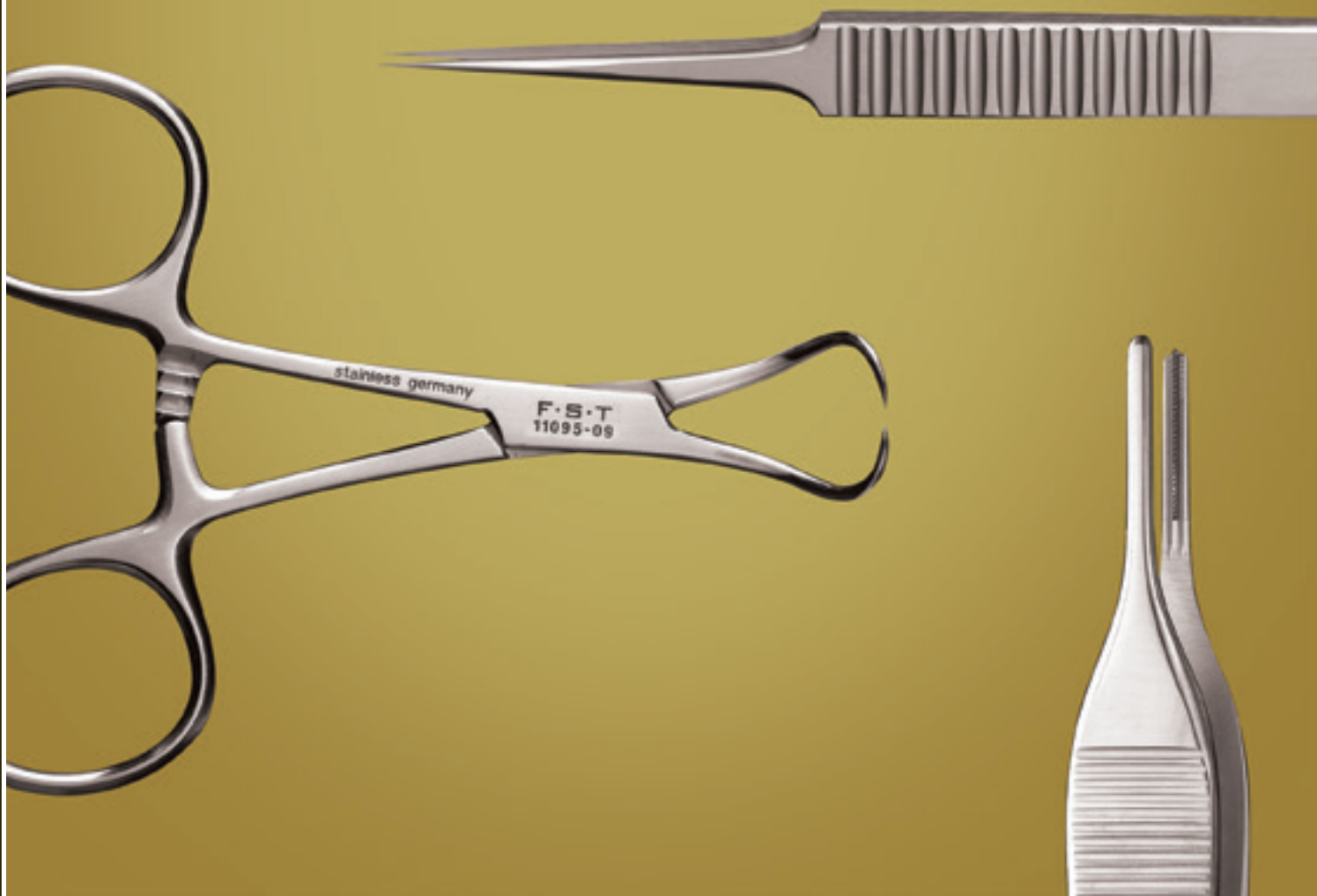

Dumont #5SF

The finest tips ever produced by Dumont.



Super fine tip
0.025 x 0.005 mm
Inox
11 cm

No. 11252-00
78,00 €

**Dumont #5
Fine Tips**

Finished under magnification and polished on the inside, the tips close flat to 3 mm and are less likely to open under excess pressure.



Biology tip
0.05 x 0.01 mm
Inox
11 cm

No. 11254-20
41,50 €

**Dumont #5
Ceramic Coated**

These forceps are non-reflective. The scratch and corrosion resistant coating guarantees durability.



Biology tip
0.05 x 0.01 mm
Ceramic coated inox
11 cm

No. 11252-50
75,50 €

Dumont #5C0

These forceps have been honed down to make this the lightest and most precise Dumont forceps available.



Biology tip
0.05 x 0.01 mm
Dumostar
11 cm

No. 11295-20
58,50 €

For information on
Dumont alloys and tip styles,
see page 189.

Dumont Micro-Blunted, Atraumatic Tipped Forceps

The sides of these forceps are distinctively ribbed to provide a better holding surface for maximum control of the instrument. The shanks are arched toward each other to transmit more holding strength to the points. The smooth inside surfaces at the tips will close flat to 5 mm with gentle pressure, increasing the total holding area considerably. The microscopically matched tips are gently blunted to prevent tissue puncture and are recommended as micro needle holders.



Straight
0.10 x 0.06 mm
Inox
11 cm

Medical #5
No. 11253-20
30,50 €



Off-center
0.13 x 0.08 mm
Inox
11.5 cm

Medical #5A
No. 11253-21
32,50 €



Short curve
0.17 x 0.10 mm
Inox
12 cm

Medical #7S
No. 11273-22
38,00 €

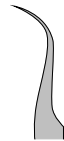

Curved
0.17 x 0.10 mm
Inox
11.5 cm

Medical #7
No. 11273-20
36,00 €



Angled 45°
0.10 x 0.06 mm
Inox
11 cm

Medical #5/45
No. 11253-25
39,50 €



Angled 90°
0.10 x 0.06 mm
Inox
11 cm

Medical #5/90
No. 11253-29
39,50 €

Dumont #55

Bevelled, like #5 but with extra light and fine shanks.



Biology tip
0.05 x 0.02 mm
11 cm

Inox
No. 11255-20
33,50 €

Dumostar
No. 11295-51
48,00 €

**MOST
POPULAR**

**Dumont #5
Mirror Finish Forceps**

The last 5 mm on the inside of the tips are highly polished to help prevent tissue from sticking. Ideal for embryos, nerves, or any other adhesive tissue.



Standard tip
0.10 x 0.06 mm
Inox
11 cm

No. 11251-23
68,00 €

Dumont #5

These are the most widely used Dumont forceps. Bevelled, very fine shanks for best visibility.



**MOST
POPULAR**

Standard tip
0.10 x 0.06 mm
11 cm

Inox
No. 11251-20
28,00 €

Dumoxel
No. 11251-30
30,50 €

Dumostar
No. 11295-00
43,50 €

Carbon
0.08 x 0.04 mm
Not autoclavable
No. 11251-10
29,50 €

**MOST
POPULAR**

Biology tip
0.05 x 0.02 mm
11 cm

Inox
No. 11252-20
33,00 €

Dumoxel
No. 11252-30
33,50 €

Dumostar
No. 11295-10
46,50 €

·TITANIUM·
No. 11252-40
38,50 €

**MOST
POPULAR**

For information on
Dumont alloys and tip styles,
see page 189.

Dumont WA #5

These newly designed forceps offer improved stability with an ergonomic body that allows the forceps to fit more comfortably in your hand. A domed end with no soldering grooves allows the forceps to be thoroughly and easily cleaned, preventing biofilm residues.



Side View

Standard tip
0.10 x 0.06 mm
Inox
12 cm

No. 11251-21
30,50 €

Biology tip
0.05 x 0.02 mm
Inox
12 cm

No. 11252-21
36,50 €

For information on
Dumont alloys and tip styles,
see page 189.

Dumont #5XL



Standard tip
0.10 x 0.06 mm
Inox
15 cm

No. 11253-10
59,50 €

Dumont #L5

Slide sleeve keeps tips together so specimens may be securely held and retained. Slide may be locked in place so that forceps can be used in regular fashion. **Autoclavable.**



Standard tip
0.10 x 0.06 mm
Inox
11 cm

No. 11253-27
66,50 €

**Dumont #5
Teflon® Coated**

These antimagnetic forceps are ideal for use in cryogenic environments and for EM samples.



Standard tip
0.10 x 0.06 mm
Teflon coated inox
11 cm

No. 11626-11
27,00 €

Dumont #5/45

45° tips for improved visibility and control.



Standard tip
0.10 x 0.06 mm
Dumoxel
11 cm

No. 11251-35
32,00 €

**Dumont #5/45
Cover Slip Forceps**

Designed to pick up cover slips out of multi-well plates. The tip width is squared for a better grip.



1 mm from tip to bend
Upper tip: 0.10 x 0.08 mm
Lower tip: 0.10 x 0.02 mm
Dumoxel
11.5 cm

No. 11251-33
57,00 €

**MOST
POPULAR**

Dumont #3

Tapered and sturdy shanks.



Standard tip
0.17 x 0.10 mm
12 cm

Dumoxel
No. 11231-30
27,00 €

Dumostar
No. 11293-00
38,50 €

Dumont #3c



Standard tip
0.17 x 0.10 mm
Inox
11 cm

No. 11231-20
25,50 €

Dumont #6

Sharply angled tips for access to difficult areas.



Standard tip
0.17 x 0.10 mm
Inox
11.5 cm

No. 11260-20
42,00 €

Dumont #7 Fine Tips

Finished under magnification and polished on the inside, the tips close flat to 3 mm and therefore less likely to open under excess pressure.



Biology tip
0.07 x 0.03 mm
Inox
11 cm

No. 11274-20
42,00 €

For information on
Dumont alloys and tip styles,
see page 189.

Dumont #7



Standard tip
0.17 x 0.10 mm
11.5 cm

Dumoxel
No. 11271-30
31,00 €

Dumostar
No. 11297-00
50,50 €

Biology tip
0.07 x 0.04 mm
11.5 cm

Dumoxel
No. 11272-30
39,50 €

Dumostar
No. 11297-10
55,00 €

•TITANIUM•

No. 11272-40
43,00 €

Dumont #7 Ceramic Coated



Biology tip
0.07 x 0.04 mm
Ceramic coated inox
11 cm

No. 11272-50
79,00 €

Dumont #7B



Standard tip
Serrated
0.17 x 0.10 mm
Inox
11 cm

No. 11270-20
36,50 €

Dumont #4

Similar to #5, but with broader shanks.



Standard tip
0.13 x 0.08 mm
Dumoxel
11 cm

No. 11241-30
28,50 €

Dumostar
No. 11294-00
41,00 €

Biology tip
0.06 x 0.04 mm
Dumoxel
11 cm

No. 11242-40
33,00 €

Dumont #2 Laminectomy Forceps

These forceps can be used to break off delicate bone during mouse laminectomies, as well as fine skull bone removal.



0.40 x 0.02 mm
Inox
12 cm

No. 11223-20
49,00 €

Dumont #2AP Epoxy Coated

Provides good insulation for up to 220 AC voltage work and highly impervious to chemical solutions. Frozen or super cold sections will not adhere to the gripping surfaces.



Tip width: 1.5 mm
Epoxy coated Inox
12 cm

No. 11220-21
18,50 €

Dumont AA**Dumont AA
Epoxy Coated**

Slip-proof acid and electric shock resistant epoxy coating covering 17.5 mm from the tips.



0.4 x 0.2 mm
Inox
12.5 cm

Pkg. of 12 forceps
No. 11210-20
249,00 €



0.4 x 0.2 mm
Epoxy coated inox
12.5 cm

Pkg. of 12 forceps
No. 11210-10
225,50 €

For information on
Dumont alloys and tip styles,
see page 189.

Dumont SS

The tips are smooth on the inside for a gentle grip. Applying full strength will not separate tips and a strong hold on the smallest specimen is ensured.



Standard tip
0.20 x 0.12 mm
Inox
13.5 cm

No. 11203-23
29,00 €



Angled 45°

No. 11203-25
32,50 €



Biology tip
0.10 x 0.06 mm
Dumoxel
13.5 cm

No. 11200-33
31,00 €

Sold only by the dozen. Not sold individually.

Dumont Mini Forceps



| | | |
|------------------------------------|------------------------------------|------------------------------------|
| 0.12 x 0.07 mm Inox 7 cm | 0.14 x 0.06 mm Inox 7 cm | 0.09 x 0.05 mm Inox 8.2 cm |
| Style 3 No. 11200-10 23,50 € | Style 4 No. 11200-12 22,00 € | Style 5 No. 11200-14 22,00 € |

Fine Forceps Repair Kit

Realign and repair fine forceps with this convenient kit. Bent forceps tips can be restraightened with the chain nose pliers. The sharpening stone has two grooves, 1.6 mm and 0.8 mm, to assist in reshaping the forceps tips. O-rings clamp the forceps shut to ensure that both shanks are equally aligned and sharpened. Instrument oil assists in producing a smooth sharp edge. Detailed instructions are included.



Kit includes:

- 1 Sharpening stone for fine forceps with ten O-rings (No. 29008-22)
- 1 Instrument oil, 50 ml bottle (No. 29055-00)
- 1 Chain nose pliers

No. 29000-00
74,00 € **MOST POPULAR**

For information on
Dumont alloys and tip styles,
see page 181.

O-Rings for Forceps

These rubber O-rings fit our Dumont forceps and keep them closed with variable degrees of pressure on the tips.

Pkg. of 10
No. 11200-00
2,00 €

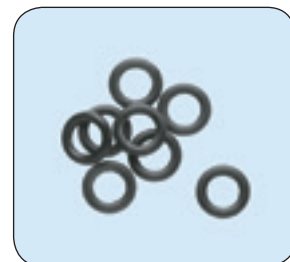

Fine Forceps Mirror Finish

The last 5 mm on the inside of the tips are highly polished to help prevent tissue from sticking. Ideal for embryos, nerves, or other adhesive tissue.



**NEW
ITEM**

0.1 x 0.06 mm
11 cm

No. 11412-11
73,00 €

0.05 x 0.02 mm
11 cm

No. 11413-11
78,00 €

Fine Forceps Broad Shanks

Straight forceps with sturdy coarse tips.



**NEW
ITEM**

0.2 x 0.12 mm
12 cm

No. 11445-12
41,00 €

Fine Forceps Self-Closing

Ideal for lifting and holding EM grids. Consistent pressure at tips. Correctly tensioned "cross-over" shanks come to a microscopically matched point.



**NEW
ITEM**

0.08 x 0.04 mm
11.5 cm

No. 11480-11
42,00 €

These forceps have the most finely executed points available. They are extremely light, superbly balanced, and have a gentle spring action. The shanks are specially designed with an arch which ensures maximum force to the tips. The tips close flat for 6 mm from the points to give a large holding area. The tips have been expertly finished under magnification.



Moria



Moria



Moria

Tip width: 0.5 mm
Blunt
10 cm



Straight
11 cm

Moria MC40
No. 11370-40
178,00 €



Curved
11 cm

Moria MC40/B
No. 11370-42
179,50 €



Straight
13 cm

Moria 9980
No. 11399-80
152,00 €



Curved
13 cm

Moria 9987
No. 11399-87
159,00 €



Smooth
Moria MC32/B
No. 11373-22
126,50 €



Smooth
Moria MC31/B
No. 11373-12
133,00 €



Microerrated
Moria MC32
No. 11370-32
135,00 €



Microerrated
Moria MC31
No. 11370-31
140,00 €

S&T®



0.3 x 0.25 mm
11 cm



Straight

No. 00108-11
126,50 €



Angled 45°

No. 00109-11
148,00 €

SuperGrip Forceps

The tips are processed with MicroCrystals®, a method developed by S&T® to infuse tungsten carbide on stainless steel. The formation of this ultra-fine coating guarantees atraumatic handling of tissue while improving the grip dramatically. The recommended use is where forceps are utilized as needle holders or when slippery tissues might be encountered.



0.3 x 0.25 mm
11 cm



The gripping surface is similar to a match head.

S&T®



Straight

No. 00632-11
151,50 €



Angled 45°

No. 00649-11
189,50 €

Bonn

The 1x2 forceps are the finest of their kind available.

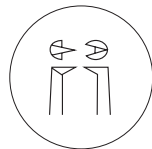

20x magnification

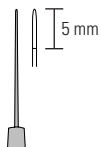

Smooth
Tip width: 0.3 mm
Tip platform: 5 mm
7 cm

No. 11083-07
179,50 €

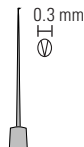

1x2 teeth
Tip width: 0.3 mm
Teeth width: 0.1 mm
7 cm

No. 11084-07
227,50 €

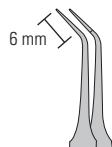

Angled 45°
Tip width: 0.4 mm
Platform
9 cm

No. 11063-07
109,50 €

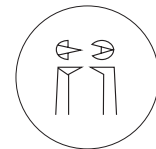

20x magnification

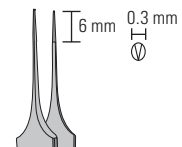

Straight
Tip width: 0.3 mm
Platform with 1x2 teeth
9 cm

No. 11090-09
184,50 €

Mirror Finish Suture Tying Forceps

A unique tip style fusing a suture tying platform and a 1x2 teeth tip for tissue manipulation.

Suture Tying Forceps

The platform tips close flat. This ensures a reliable grip on sutures.

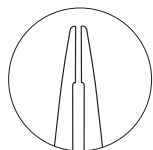

S&T[®]

Tip diameter: 0.3 mm
Tying platform: 6 mm
13.5 cm

No. 00272-13
151,50 €

Suture Tying Forceps

The platform tips close flat. This ensures a reliable grip on sutures.

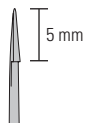

Tip diameter: 0.5 mm
Tying platform: 5 mm
10 cm

No. 18025-10
117,00 €

Round Handled Suture Tying Forceps

Round handles allow easy fingertip adjustments.

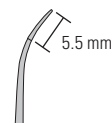

Tip diameter: 0.35 mm
Tying platform: 5.5 mm
10.5 cm

No. 18026-10
159,00 €

Vial Forceps

Tips taper for 6 cm allowing easy access to specimens in vials.

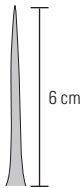
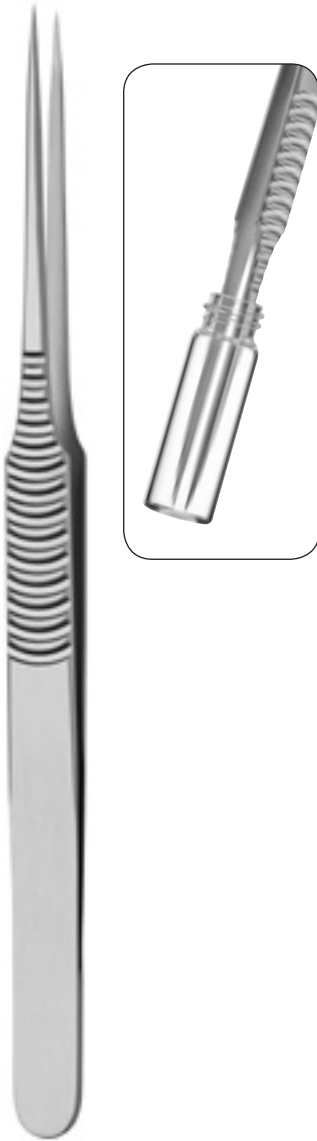

Tip diameter: 0.5 mm
15 cm

No. 11006-15
130,50 €

EVO Forceps

An evolutionary series of ergonomic instruments that are lighter than titanium but still have all the benefits of stainless steel. The fully fenestrated spring body is designed with a stability rod to provide balance in your hand.



Tip diameter: 0.5 mm
15 cm



Straight

No. 11800-00
389,00 €



Curved

No. 11800-01
424,50 €

Vetro Grasping Forceps

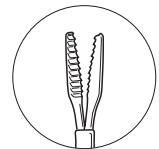

Serrated
Tip diameter: 0.7 mm
14 cm

No. 11900-14
702,50 €

Bishop-Harman

Extra light, fenestrated handles ensure a good grip.



Tip width: 0.6 mm
7 cm



Straight
Serrated

No. 11064-07
46,00 €



Curved
Serrated

No. 11065-07
49,00 €

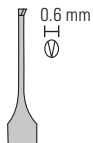

Straight
1x2 teeth

No. 11066-07
53,00 €



Curved
1x2 teeth

No. 11067-07
58,00 €



Tip width: 0.5 mm
8.5 cm



Serrated

No. 11069-08
105,50 €

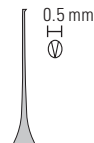

1x2 teeth

No. 11070-08
138,50 €

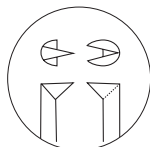

10x magnification



Octagon Forceps

The octagon shaped grip provides a particularly secure finger hold.

Tip width: 0.8 mm
9.5 cm



Straight
Serrated

No. 11040-08
96,00 €



Curved
Serrated

No. 11041-08
105,50 €

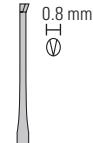

Straight
1x2 teeth

No. 11042-08
106,50 €



Curved
1x2 teeth

No. 11043-08
113,50 €

Extra Fine Graefe Forceps



Tip width: 0.5 mm
10 cm



Serrated
No. 11150-10
44,50 €



Serrated
No. 11151-10
48,00 €



Serrated
No. 11152-10
47,50 €

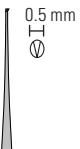

1x2 teeth
No. 11153-10
50,00 €



1x2 teeth
No. 11154-10
53,00 €



1x2 teeth
No. 11155-10
52,50 €

Graefe Forceps



Tip width: See below
10 cm



Serrated
Tip width: 0.8 mm
No. 11050-10
41,00 €



Serrated
Tip width: 0.8 mm
No. 11051-10
43,50 €

MOST POPULAR



Serrated
Tip width: 0.8 mm
No. 11052-10
43,00 €



Serrated
Tip width: 0.8 mm
No. 11049-10
45,00 €

·TITANIUM·

Tip width: 1.2 mm
No. 11650-10
71,50 €

·TITANIUM·

Tip width: 1.2 mm
No. 11651-10
75,00 €

·TITANIUM·

Tip width: 1.2 mm
No. 11652-10
81,50 €

For more information on
Titanium see page 183.

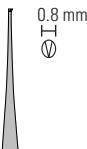

1x2 teeth
Tip width: 0.8 mm
No. 11053-10
44,50 €



1x2 teeth
Tip width: 0.8 mm
No. 11054-10
48,00 €



1x2 teeth
Tip width: 0.8 mm
No. 11055-10
47,50 €

The tips of these forceps arch toward each other, closing flat. Exceptional gripping power is possible with minimal damage to tissue. A limit pin prevents excessive applied pressure.



Slide lock
Smooth
Tip width: 1 mm
11 cm

No. 11062-10
99,00 €



Tip thickness: 0.2 mm
10 cm

No. 11071-10
94,50 €

Pierse Fixation Forceps

For exceptional gripping power with no damage to sclera, vascular sheath and epineurium.

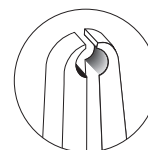

Tissue retention hole of 0.3 mm behind tips.

Straight
0.1 x 0.4 mm
13 cm

No. 18155-13
112,00 €

Plastic Forceps

These forceps are non-magnetic, acid resistant and able to withstand temperatures up to 240°C (464°F). Tips do not spread under pressure.



Acetyl
11.5 cm
Pkg. of 10 forceps

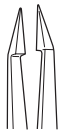

Sharp straight
0.40 x 0.25 mm

No. 11700-00
15,00 €



Blunt straight
1.5 x 0.40 mm

No. 11700-03
15,00 €



Sharp curved
0.30 x 0.20 mm

No. 11700-01
14,00 €



Blunt curved
1.5 x 0.40 mm

No. 11700-04
15,00 €

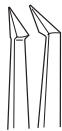

Sharp 45°
0.30 x 0.20 mm

No. 11700-02
14,00 €

Cross Action Forceps

These tissue transport forceps have a gentle action.

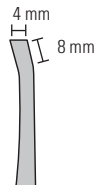

Cross serrated
Tip width: 4 mm
Tip depth: 8 mm
10 cm

No. 11075-00
45,00 €

Cover Glass Forceps



10.5 cm

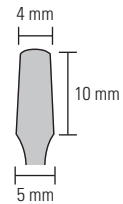

Straight

No. 11074-02
21,50 €

Angled

No. 11073-10
27,50 €

Ring Forceps

For transport of tissue and organs. With limit screw to prevent excessive applied pressure.



ID: 1 mm
OD: 1.5 mm
8.5 cm

No. 11101-09
47,00 €

ID: 2.2 mm
OD: 3 mm
9 cm

No. 11103-09
43,00 €

ID: 4.8 mm
OD: 6 mm
9 cm

No. 11106-09
41,00 €

Live Insect Handling Forceps

Very delicate.

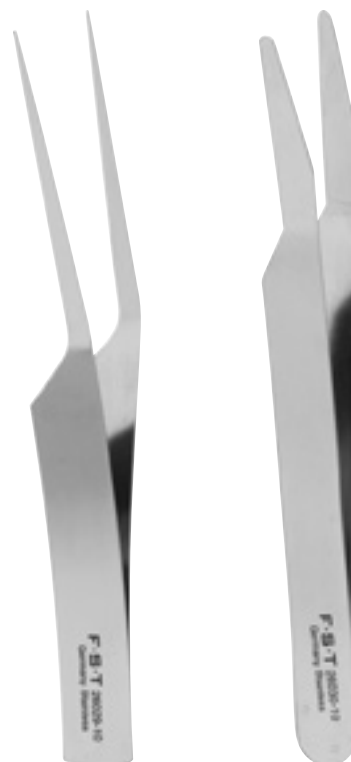

Narrow
10 cm

No. 26029-10
20,50 €

Wide
10 cm

No. 26030-10
18,00 €

Micro-Adson

Our most delicate version of the popular Adson forceps.



Tip width: 0.8 mm
12 cm

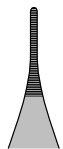

Serrated

No. 11018-12
33,50 €

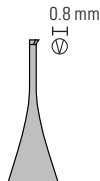

1x2 teeth

No. 11019-12
39,00 €

Micro-Adson with Fenestrated Handle

Our delicate Micro-Adson forceps, with five windows to aid in stability and easy finger adjustments.



Tip width: 0.8 mm
12 cm



Serrated

No. 11020-12
40,00 €

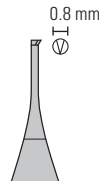

1x2 teeth
with platform

No. 11022-12
51,00 €

Adson

Wide, strong grip with narrow tips.



Tip width: 1.5 mm
12 cm

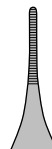

Serrated

No. 11006-12
20,00 €

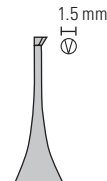

1x2 teeth

No. 11027-12
23,00 €



Cross serrated
tungsten carbide
inlaid tip

No. 11506-12
108,00 €

**TUNGSTEN
CARBIDE**

For more information on tungsten carbide, see page 183.

Adson DeBakey

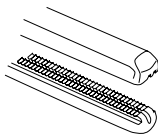
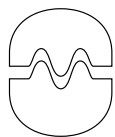
**Atraumatic
DeBakey Serrations**

This tooth pattern, as shown, consists of one row of atraumatic teeth meshed with two opposite rows of atraumatic teeth.

These two forceps are ideal for gentle, atraumatic gripping of vessels, tissue and other delicate structures.



DeBakey serrations
Tip width: 1.5 mm
12.5 cm

No. 11617-12
90,50 €



DeBakey serrations
Tip width: 1.5 mm
15 cm

No. 11616-15
93,00 €

Adson-Graefe



Fine sharp teeth
Tip width: 4.5 mm
12.5 cm

No. 11030-12
69,00 €

Adson-Brown

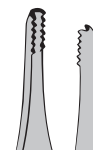

Shark teeth
Tip width: 1.4 mm
12 cm

No. 11627-12
41,50 €

Semken

Slim pattern with long, narrow shanks and gentle spring action.

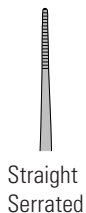

| Tip width (mm) | Length (cm) | Item | Price |
|----------------|-------------|--------------|---------|
| 1.3 | 13 | No. 11008-13 | 23,00 € |
| 1.5 | 15 | No. 11008-15 | 23,00 € |

•TITANIUM•

| | | | |
|-----|----|--------------|---------|
| 1.5 | 15 | No. 11608-15 | 71,00 € |
|-----|----|--------------|---------|

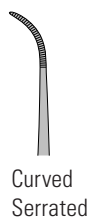

| Tip width (mm) | Length (cm) | Item | Price |
|----------------|-------------|--------------|---------|
| 1.3 | 13 | No. 11009-13 | 24,50 € |
| 1.5 | 15 | No. 11009-15 | 26,00 € |



Narrow Pattern

Lighter spring action than standard pattern for grasping more delicate tissue.

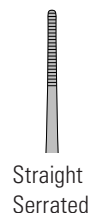

| Tip width (mm) | Length (cm) | Item | Price |
|----------------|-------------|--------------|---------|
| 2 | 12 | No. 11002-12 | 13,50 € |
| 2.15 | 13 | No. 11002-13 | 15,00 € |
| 2.25 | 14.5 | No. 11002-14 | 16,00 € |
| 2.35 | 16 | No. 11002-16 | 18,00 € |
| 2.4 | 18 | No. 11002-18 | 24,50 € |
| 2.75 | 20 | No. 11002-20 | 27,00 € |
| 3.2 | 25 | No. 11002-25 | 36,50 € |

•TITANIUM•

| | | | |
|------|------|--------------|---------|
| 2.25 | 14.5 | No. 11602-14 | 62,50 € |
|------|------|--------------|---------|

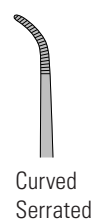

| Tip width (mm) | Length (cm) | Item | Price |
|----------------|-------------|--------------|---------|
| 2 | 12 | No. 11003-12 | 17,00 € |
| 2.15 | 13 | No. 11003-13 | 19,00 € |
| 2.25 | 14.5 | No. 11003-14 | 20,50 € |
| 2.35 | 16 | No. 11003-16 | 23,50 € |
| 2.4 | 18 | No. 11003-18 | 17,50 € |
| 2.75 | 20 | No. 11003-20 | 31,50 € |



•TITANIUM•

For more information on Titanium see page 183.

Standard Pattern

Broad pattern with strong spring action.

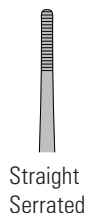

| Tip width (mm) | Length (cm) | Item | Price |
|----------------|-------------|--------------|---------|
| 2.5 | 12 | No. 11000-12 | 11,50 € |
| 2.8 | 13 | No. 11000-13 | 12,00 € |
| 3.25 | 14.5 | No. 11000-14 | 14,00 € |
| 3.3 | 16 | No. 11000-16 | 14,50 € |
| 3.7 | 18 | No. 11000-18 | 19,50 € |
| 3.75 | 20 | No. 11000-20 | 22,50 € |
| 3.9 | 25 | No. 11000-25 | 29,00 € |
| 4 | 30 | No. 11000-30 | 33,00 € |

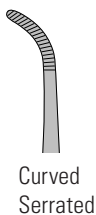

| Tip width (mm) | Length (cm) | Item | Price |
|----------------|-------------|--------------|---------|
| 2.5 | 12 | No. 11001-12 | 16,50 € |
| 2.8 | 13 | No. 11001-13 | 17,00 € |
| 3.25 | 14.5 | No. 11001-14 | 18,00 € |
| 3.3 | 16 | No. 11001-16 | 21,00 € |
| 3.7 | 18 | No. 11001-18 | 15,00 € |
| 3.75 | 20 | No. 11001-20 | 31,00 € |



Mouse Handling Forceps

Long handles make picking up small rodents easy and help prevent bites.



Forceps with serrated silicone tips
Gripping surface: 15 x 20 mm
21 cm

No. 11036-20
36,50 €



Replacement silicone tips

Pkg of 2 tips
No. 11036-90
12,00 €



Slim 1x2 teeth

| | |
|--------------|--------------|
| 10 cm | 14.5 cm |
| No. 11023-10 | No. 11023-14 |
| 18,50 € | 18,00 € |

| | |
|--------------|--------------|
| 12 cm | 15.5 cm |
| No. 11023-12 | No. 11023-15 |
| 18,00 € | 19,50 € |



1x2 teeth

| |
|--------------|
| 12 cm |
| No. 11021-12 |
| 12,50 € |

| |
|--------------|
| 14.5 cm |
| No. 11021-14 |
| 15,00 € |

| |
|--------------|
| 15.5 cm |
| No. 11021-15 |
| 16,00 € |



2x3 teeth

| |
|--------------|
| 14.5 cm |
| No. 11022-14 |
| 21,00 € |

| |
|--------------|
| 15.5 cm |
| No. 11022-15 |
| 23,00 € |



1x2 teeth

| |
|--------------|
| 14 cm |
| No. 11029-14 |
| 20,50 € |

Used with rongeur No. 16021-14 (page 36) in laminectomy to securely hold spinal column.

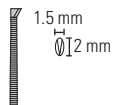
Gillies

Serrated
1x2 teeth
15 cm

No. 11028-15
30,50 €

Russian

Special cupped pattern for superior grip.

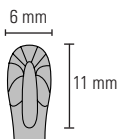

15 cm

No. 11026-15
41,50 €

Organ Holding Forceps

With limit screw to prevent excessive applied pressure.

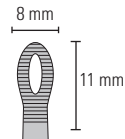

Serrated
14.5 cm

No. 11031-15
118,50 €

London Forceps

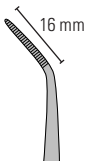

Angled
Serrated
16 cm

No. 11080-02
19,50 €

Titanium Forceps



·TITANIUM·

For more information on
Titanium see page 183.



Straight
Serrated
16 cm

No. 11602-16
70,50 €

Gerald Forceps



Straight
Serrated
18 cm

No. 11014-18
34,00 €

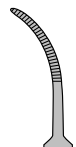

Curved
Serrated
18 cm

No. 11015-18
39,00 €

Taylor Forceps

Serrated and smooth versions available.



Straight
Serrated
17 cm

No. 11010-17
30,00 €



Curved
Serrated
17 cm

No. 11011-17
33,50 €



Straight
Smooth
17 cm

No. 11016-17
28,50 €



Curved
Smooth
17 cm

No. 11017-17
31,50 €

Potts-Smith Forceps

Straight
Serrated

18 cm
No. 11012-18
22,00 €

21 cm
No. 11012-21
12,00 €

25 cm
No. 11012-25
32,50 €



Curved
Serrated

18 cm
No. 11013-18
29,50 €

21 cm
No. 11013-21
20,50 €



Straight
1x2 teeth
18 cm

No. 11024-18
26,50 €



Curved
1x2 teeth
18 cm

No. 11025-18
18,00 €

Ultra Fine Hemostat



Tip width: 0.6 mm
Smooth
12 cm



Straight

No. 13020-12
68,00 €



Curved

No. 13021-12
73,50 €

Fine Hemostat



Tip width: 1 mm
Smooth
12 cm



Straight

No. 13006-12
67,00 €



Curved

No. 13007-12
70,50 €

Micro-Mosquito



Tip width: 1.3 mm
Serrated
12 cm



Straight

No. 13010-12
66,00 €



Curved

No. 13011-12
70,00 €

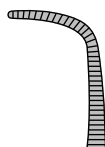

Angled 90°

No. 13012-12
70,00 €

Halsted-Mosquito



Tip width: 1.1 mm
Serrated
12.5 cm

Tip width: 1 mm
Serrated
Left handed
12.5 cm



Straight

No. 13008-12
24,00 €



Curved

No. 13009-12
26,50 €



Straight

LEFT HANDED
No. 13108-12
81,50 €



Curved

LEFT HANDED
No. 13109-12
83,50 €

Hartman



Tip width: 1 mm
Serrated
10 cm



Straight

No. 13002-10
27,50 €



Curved

No. 13003-10
30,00 €

**MOST
POPULAR**

Hill



Side View

Tip width: 1.4 mm
Serrated
12 cm



Curved

No. 13111-12
78,00 €

Crile



Tip width: 1.5 mm
Serrated
14 cm



Straight

No. 13004-14
27,00 €

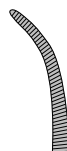

Curved

No. 13005-14
28,50 €

Kelly



Tip width: 1.5 mm
Serrated
14 cm



Straight

No. 13018-14
27,00 €



Curved

No. 13019-14
29,50 €

Baby-Mixer

Providence-Hospital

HEMOSTATS



Tip width: 1.3 mm
Serrated
14 cm

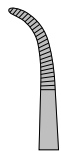

Curved

No. 13013-14
44,50 €



Tip width: 1.5 mm
Serrated
14 cm



Straight

No. 13014-14
33,50 €



Curved

No. 13015-14
36,50 €

Backhaus Towel Forceps

9 cm

No. 11095-09
26,50 €

13 cm

No. 11095-13
29,00 €**Allis Forceps**

Tissue and organ holding forceps.

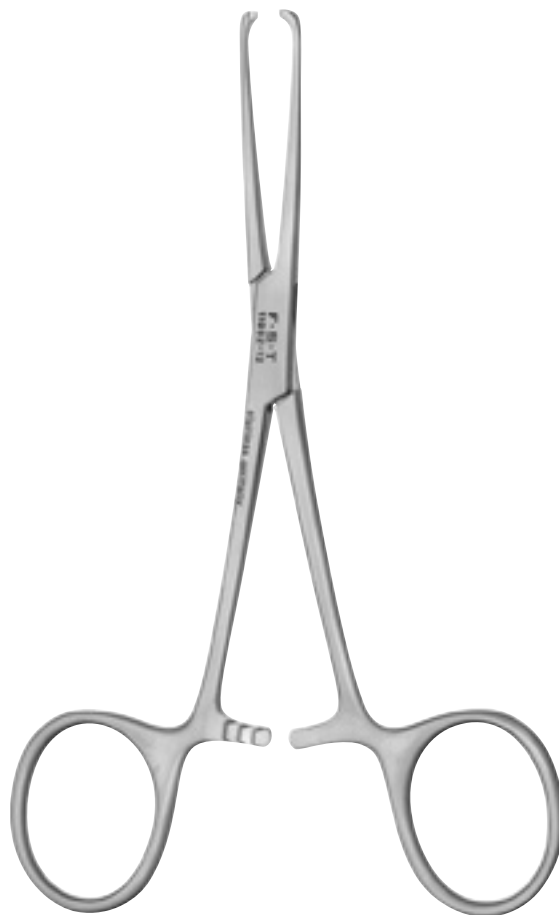
 4 mm
5x6 teeth
Tip width: 4 mm
15 cmAllis
No. 11091-15
43,50 €
 3 mm
4x5 teeth
Tip width: 3 mm
12 cmAllis-Baby
No. 11092-12
41,00 €

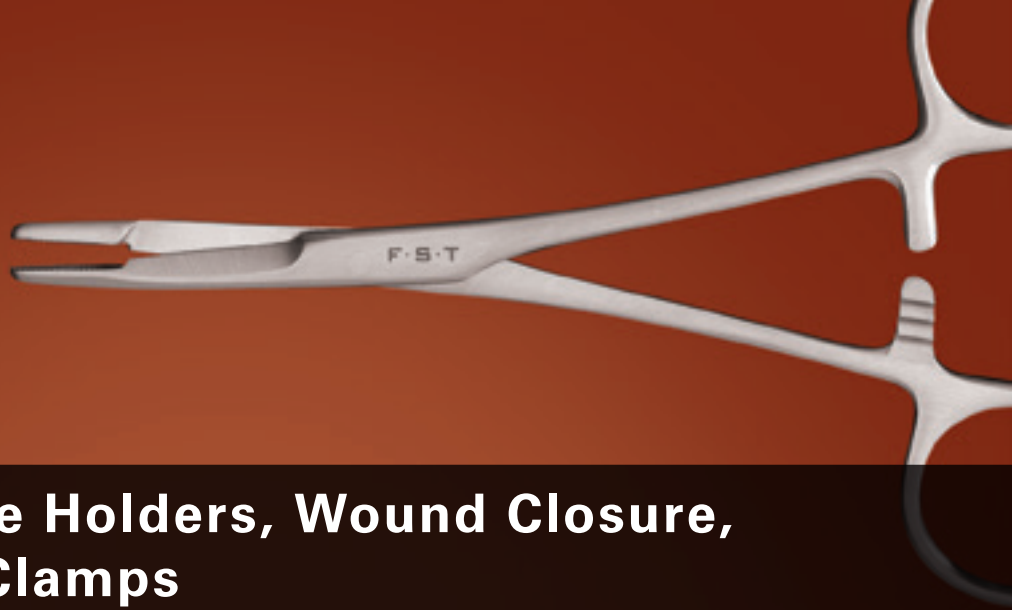

Probes, Needle Holders, Wound Closure, Retractors & Clamps

| | | |
|----------------------|-------|-----------|
| Probes & Hooks | Pages | 99 – 103 |
| Spatulae | Pages | 102 – 105 |
| Pins & Holders | Pages | 106 – 107 |
| Spoons | Page | 108 |
| Wound Closure | Pages | 109 – 121 |
| Retraction | Pages | 122 – 129 |
| Vascular Instruments | Pages | 130 – 139 |

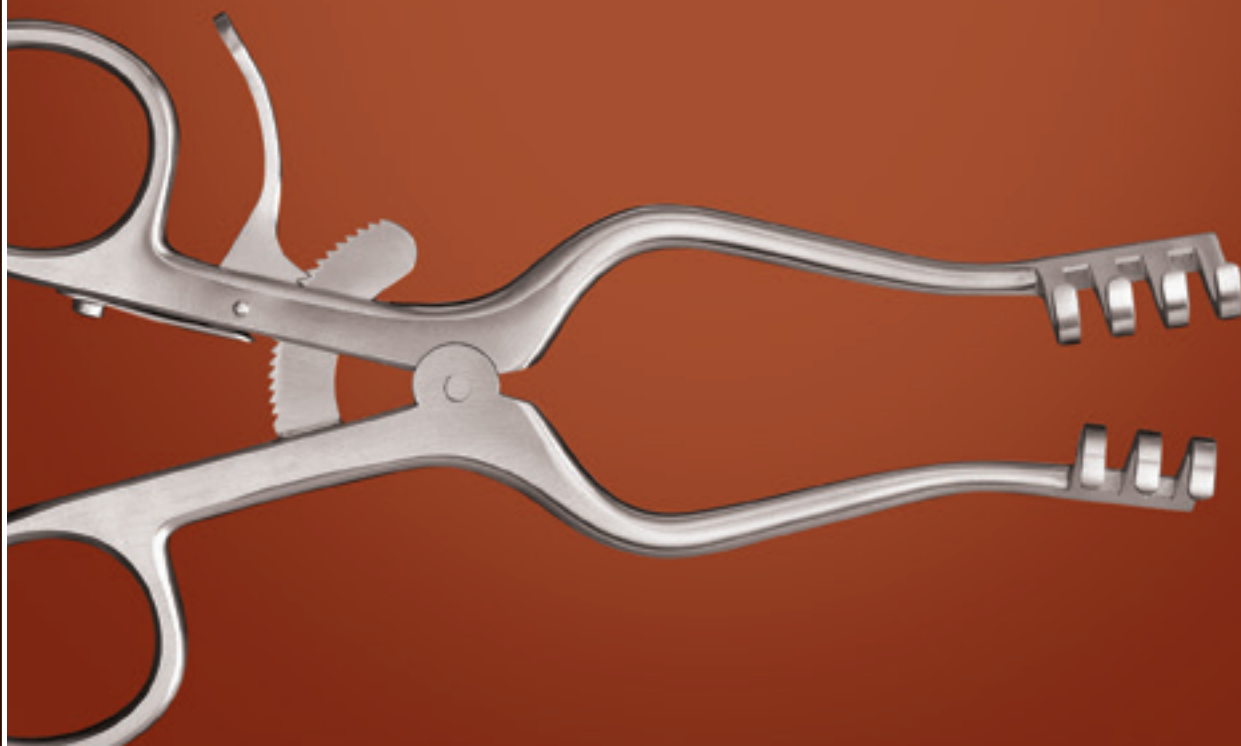

Double Pronged Pick

For peritoneum, pleura, endocardium, organ capsules and skin.
Grasps and lifts skin, tissue and dura, etc.

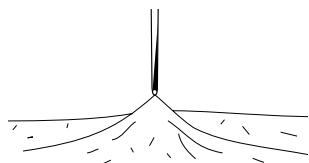

The tip consists of two very sharp, nearly horizontally opposed points. By applying gentle downward pressure and twisting slightly in a clockwise fashion, the points will embed themselves horizontally into fine membranes or skin, etc., so that it may be lifted upward. This instrument also has been used successfully when separating fine tissue from an underlying area that is not to be cut.



11 cm

No. 18067-11
90,00 €

Spinal Cord Hook

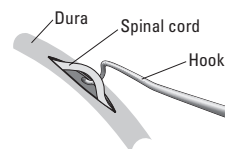

Shaped like a ligation aid and sized to isolate the spinal cord from the dura of adult mice and neonatal rats. The cord can then be cut with minimal damage to the dura.



Tip diameter: 3 mm
12 cm

No. 10162-12
89,00 €

Bonn Micro Probes



Length: 13.5 cm



Actual size

Straight
Tip diameter: 0.025 mm

No. 10030-13
46,50 €



Actual size

Angled 45°
Tip diameter: 0.025 mm

No. 10032-13
50,50 €



Actual size

Curved
Tip diameter: 0.025 mm

No. 10031-13
50,50 €



Actual size

Large curve
Tip diameter: 0.038 mm

No. 10033-13
32,00 €

Micro Points



Length: 15.5 cm



200% of actual size

Angled 90° short
Tip diameter: 0.05 mm

No. 10063-15
59,50 €



200% of actual size

Angled 90°
Tip diameter: 0.02 mm

No. 10065-15
57,50 €



200% of actual size

Angled 45°
Tip diameter: 0.038 mm

No. 10066-15
60,00 €

Probes and Explorers



Length: 15.5 cm



Actual size

Straight
Tip diameter: 0.25 mm

No. 10140-01 **MOST POPULAR**
8,00 €



Actual size

Short angle
Tip diameter: 0.12 mm

No. 10140-04
9,50 €



Actual size

Angled
Tip diameter: 0.15 mm

No. 10140-02
9,00 €



Actual size

Long angled
Tip diameter: 0.15 mm

No. 10140-03
8,50 €

Micro Hooks



Length: See below



175% of actual size

Short round hook
Tip diameter: 0.05 mm
Length: 13 cm

No. 10064-14
60,50 €



175% of actual size

Sharp hook
Tip diameter: 0.075 mm
Length: 12 cm

No. 10061-12
48,00 €



175% of actual size

Blunt hook
Tip diameter: 0.30 mm
Length: 12 cm

No. 10062-12
47,50 €

Titanium Micro Point, Y-Hook, and Spatula

These instruments are lightweight, color coded for easy identification, have an ergonomic design and a non-reflective surface.

Micro Point



•TITANIUM•

For more information on Titanium see page 183.

Y-Hook



•TITANIUM•

For more information on Titanium see page 183.

Micro Spatula



•TITANIUM•

For more information on Titanium see page 183.



Angled 45°
Tip diameter: 0.4 mm
Titanium
12.5 cm

No. 10165-11
87,00 €

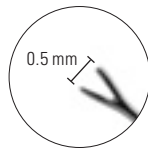

Angled 45°
Tip width: 0.5 mm
Titanium
12.5 cm

No. 10166-11
88,00 €

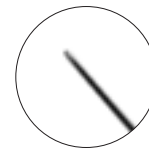

Angled 30°
Tip width: 0.6 mm
Tip thickness: 0.25 mm
Titanium
12.5 cm

No. 10167-11
106,50 €

Gross Anatomy Probe



Tip diameter: 1.2 mm
15 cm

No. 10088-15
10,50 €

Vessel Dilating Probe



Tip diameter: 0.6 mm
12.5 cm

No. 10160-13
105,00 €

Combination Probe and Spatula

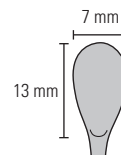

14 cm

No. 10090-13
83,00 €

Micro Spatula



Tip width: 1 mm
Tip thickness: 0.25 mm
11 cm

No. 10089-11
73,00 €

**Mirror Finish
Micro Spatula**

Mirror finished to provide a non-stick spatula.



Tip width: 0.8 mm
Tip thickness: 0.25 mm
12 cm

No. 10087-12
104,00 €

**Double-Ended
Micro Spatula**

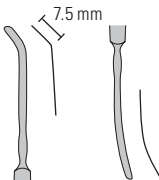

Tip width: 2 mm
Tip thickness: 0.3 mm
13 cm

No. 10091-12
95,50 €

Iris Spatulae



Tip width: 3 mm
Tip thickness: 0.4 mm
13 cm

No. 10094-13
44,50 €



Tip width: 1.7 mm
Tip thickness: 0.3 mm
13 cm

No. 10093-13
44,00 €

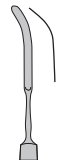

Tip width: 1.8 mm
Tip thickness: 0.3 mm
12 cm

No. 10092-12
45,50 €

Mini Hippocampal Dissecting Tool

The instrument ends are malleable to allow you to adjust their shape to the correct angle for optimal positioning.



14.5 cm

No. 10099-12
123,50 €

Hippocampal Dissecting Tool

The instrument ends are malleable to allow you to adjust their shape to the correct angle for optimal positioning.



16 cm

No. 10099-15
59,00 €

Pin Holder

Light weight.



Nickel-plated chuck
Aluminum handle
Jaw opening: 0–1 mm
17 cm

No. 26018-17
17,00 €

Pin Holder



**MOST
POPULAR**

Nickel-plated
Jaw opening: 0–1 mm
12 cm

No. 26016-12
27,00 €

Self Holding Pin and Bone Screw Forceps

Designed with a serrated tip and grooved cup for a stable and secure grip, these forceps hold pins and screws allowing precise placement at your target area. They are compatible with all Fine Science Tools insect pins, minutien pins and bone screws.



Polished stainless steel
14 cm

No. 26100-00
78,00 €

Insert Pins

All insert pins fit any of our pin holders.
Pins are antimagnetic and acid resistant.

Stainless steel
5 cm
4,00 €



No. 26007-01 -02 -03 -04 -05

Black Anodized Minutien Pins

These high quality pins are black for best visibility
under high magnification and bright light.

Tip diameter: 0.0175 mm
Rod diameter: 0.15 mm
10 mm

Box of 500 pins
No. 26002-15
21,50 €



Stainless Steel Minutien Pins

The thinnest and finest pins available.

Tip diameter: 0.0125 mm
Rod diameter: 0.1 mm
10 mm

Box of 500 pins
No. 26002-10
21,00 €



Tip diameter: 0.02 mm
Rod diameter: 0.2 mm
10 mm

Box of 500 pins
No. 26002-20
21,00 €

Black Anodized Insect Pins

Nylon heads
Tip diameter: 0.03 mm

Pkg. of 100 pins
8,00 €

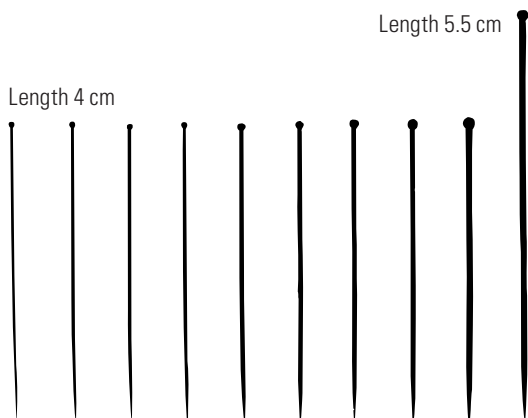

| Size | 000 | 00 | 0 | 1 | 2 | 3 | 4 | 5 | 6 | 7 |
|-------------------|-----|-----|-----|-----|-----|-----|-----|-----|-----|-----|
| Rod diameter (mm) | .25 | .30 | .35 | .40 | .45 | .50 | .55 | .60 | .65 | .70 |
| No. 26000 | -25 | -30 | -35 | -40 | -45 | -50 | -55 | -60 | -65 | -70 |

Stainless Steel Insect Pins

Nylon heads
Tip diameter: 0.03 mm

Pkg. of 100 pins
11,00 €

| Size | 000 | 00 | 0 | 1 | 2 | 3 | 4 | 5 | 6 | 7 |
|-------------------|-----|-----|-----|-----|-----|-----|-----|-----|-----|-----|
| Rod diameter (mm) | .25 | .30 | .35 | .40 | .45 | .50 | .55 | .60 | .65 | .70 |
| No. 26001 | -25 | -30 | -35 | -40 | -45 | -50 | -55 | -60 | -65 | -70 |

Etched Tungsten Micro Needles

These tungsten micro needles are drawn to a 1 micron tip and three different rod diameters are offered. Each provides lateral stability as well as minimal spring action during manipulation. The micro needles can be used with our pin holders shown on page 106.

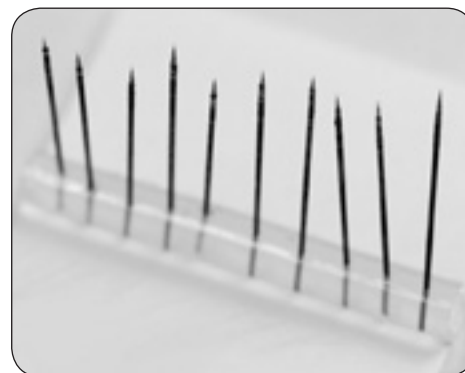

Tip diameter: 1 µm (0.001 mm)
12 mm

Box of 10 needles

| Rod diameter (mm) | Item | Price |
|-------------------|--------------|----------|
| 0.125 | No. 10130-05 | 104,00 € |
| 0.25 | No. 10130-10 | 104,00 € |
| 0.5 | No. 10130-20 | 104,00 € |

Spoon



Diameter: 8 mm
Depth: 2 mm
12.5 cm

Moria 1121B
No. 10321-08
154,00 €

Mini Perforated Spoon

Most commonly used to take embryos out of solution and handling very small organs.



Perforations are
0.8 mm in diameter.

Diameter: 8 mm
Depth: 1 mm
10 cm

Moria MC 17C
No. 10370-19
154,00 €

Perforated Spoon

Most commonly used to take embryos out of solution and handling very small organs.



Perforations are
0.9 mm in diameter.

**MOST
POPULAR**

Diameter: 15 mm
Depth: 3 mm
14.5 cm

Moria MC 17 BIS
No. 10370-18
152,00 €

Diameter: 20 mm
Depth: 5 mm
14.5 cm

Moria MC 17
No. 10370-17
135,50 €

Mirror Finish Cutting Spoon

Non stick cutting spoon.



Diameter: 4.5 mm
Depth: 0.15 mm
13 cm

No. 10360-13
119,00 €

EVO Needle Holder

Lighter than titanium but with all the benefits of stainless steel. The fully fenestrated spring body has a stability rod to provide balance in your hand.



Straight
15 cm

Without lock
No. 12800-00
429,00 €

Cautionary note: Never use a micro needle holder with needles that are too thick, as this can easily damage the fine jaws. Use only micro needles of less than 0.2 mm diameter (see page 116).

Castroviejo

Micro pattern, with slightly blunted tips.



Straight
9 cm

With lock
No. 12060-01
209,50 €

Without lock
No. 12060-02
195,50 €

Curved
9 cm

With lock
No. 12061-01
208,00 €

Without lock
No. 12061-02
202,50 €

Needle Holder with Suture Cutter



Curved
Cutting edge: 3.5 mm
14 cm

Without lock
No. 12075-14
454,50 €

Round Handled Needle Holder

Round handles allow easy fingertip adjustments.



Straight
12.5 cm

With lock
No. 12075-12
263,50 €

Without lock
No. 12076-12
232,00 €

Cautionary note: Never use a micro needle holder with needles that are too thick, as this can easily damage the fine jaws. Use only micro needles of less than 0.2 mm diameter (see page 116).

Mathieu

Extra slim and narrow profile, with squeeze-lock.
Facilitates excellent wrist motion for suturing.



14 cm

With lock
No. 12010-14
77,00 €



With tungsten carbide jaws
14 cm

With lock
No. 12510-14
147,50 €

TUNGSTEN CARBIDE

Castroviejo with Tungsten Carbide Jaws



TUNGSTEN CARBIDE

For more information on tungsten carbide, see page 183.



With tungsten carbide jaws
14 cm

With lock
No. 12565-14
244,50 €

Halsey



Smooth
13 cm

No. 12001-13
32,50 €



With tungsten
carbide jaws
13 cm

No. 12501-13
101,00 €

**TUNGSTEN
CARBIDE**

Halsey with Tungsten Carbide Jaws



**TUNGSTEN
CARBIDE**

For more information on
tungsten carbide, see page 183.



With tungsten
carbide jaws
12.5 cm

No. 12500-12
122,50 €

**MOST
POPULAR**

Olsen-Hegar with Suture Cutter



10 mm cutting edge
1.5 mm jaw surface
12 cm



15 mm cutting edge
2 mm jaw surface
14 cm

MOST POPULAR

No. 12002-12
94,00 €

No. 12002-14
68,00 €



No. 12102-12
98,00 €

Olsen-Hegar with Suture Cutter and Tungsten Carbide Jaws



TUNGSTEN CARBIDE

For more information on tungsten carbide, see page 183.



With tungsten carbide jaws
10 mm cutting edge
1.5 mm jaw surface
12 cm

No. 12502-12
150,00 €



With tungsten carbide jaws
15 mm cutting edge
2 mm jaw surface
14 cm

No. 12502-14
152,50 €



No. 12512-12
156,50 €

NEEDLE HOLDERS

Crile-Wood



15 cm

No. 12003-15
35,00 €



With tungsten
carbide jaws
15 cm

No. 12503-15
107,50 €



No. 12504-15
95,00 €

**TUNGSTEN
CARBIDE**

Mayo-Hegar



16 cm
No. 12004-16
42,00 €

18 cm
No. 12004-18
44,00 €

Slim Elongated Needle Holder with Tungsten Carbide Jaws

Ryder Mini-Select Needle Holder

This needle holder has been uniquely fashioned with tungsten carbide dust tips, giving the clamping platform an extra secure grip.



Side View

**TUNGSTEN
CARBIDE**

For more information on tungsten carbide, see page 183.

**TUNGSTEN
CARBIDE**

For more information on tungsten carbide, see page 183.



With tungsten carbide jaws
15 cm

No. 12005-15
154,00 €



With tungsten carbide dust tips
15 cm

No. 12505-15
180,00 €

NEEDLE HOLDERS

Microsurgical Needles with Suture Thread Attached

The combination of proprietary needle design technology and state-of-the-art manufacturing techniques has enabled S&T to provide a microsurgical needle that is unmatched in the industry. S&T microsurgical needles provide frictionless tissue penetration. They are inspected under the microscope at critical stages during the manufacturing process, and a multi-point final inspection of each suture and needle combination ensures a high quality product. The suture-to-needle attachment is tested to higher standards than the USP specifications.

Features:

- Needle and thread combination comprising of non-absorbable black nylon polyamide monofilament thread and stainless steel 3/8 circle needle.
Nylon is suitable for closing ophthalmic, neurological and microvascular wounds.
- 3/8 circle precision taper point. Stainless steel needle honed under microscope by hand. Superfine round tip with flattened body to improve stability in needle holder. Easy penetration. Precise stitch placement.
- Grinding geometry and suture needle attachment are directed toward frictionless tissue penetration.
- Each needle suture combination is individually packed and sealed in a peel-open blister pack.

Sterile

Pkg. of 12 disposable units

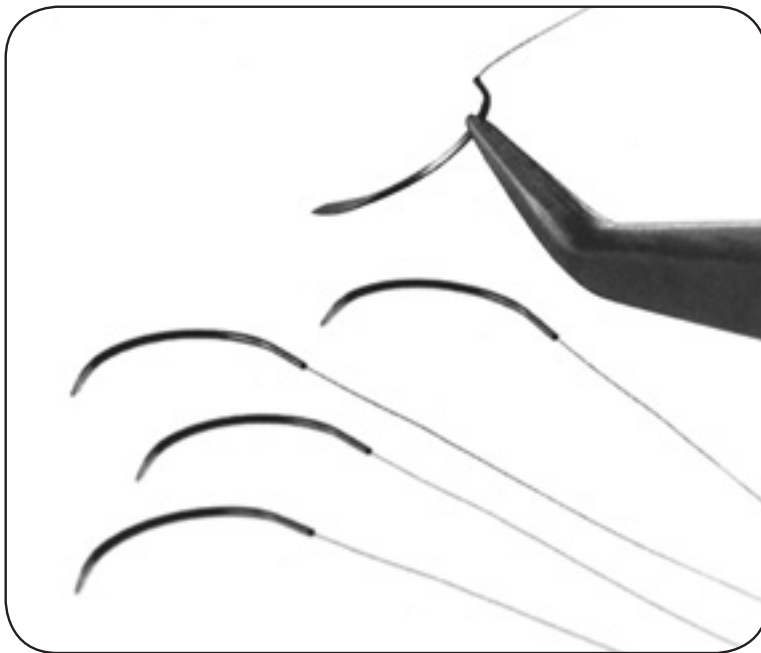

Enlarged view

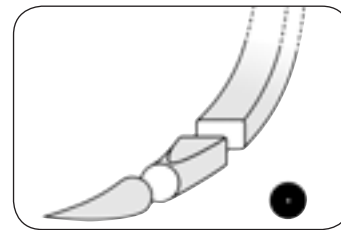

Standard taper point needle



| Suture size | Suture length (cm) | Needle diameter (micron) | Needle diameter (mm) | Needle chord length (mm) | Circle | Arch (mm) | Item | Price |
|-------------|--------------------|--------------------------|----------------------|--------------------------|--------|-----------|--------------|----------|
| 11/0 | 10 | 50 | 0.05 | 3 | 3/8 | 3.8 | No. 12051-11 | 401,00 € |
| 10/0 | 10 | 70 | 0.07 | 3 | 3/8 | 3.8 | No. 12051-10 | 269,00 € |
| 9/0 | 15 | 100 | 0.1 | 4 | 3/8 | 5.1 | No. 12051-09 | 188,50 € |
| 8/0 | 15 | 140 | 0.14 | 5 | 3/8 | 6.4 | No. 12051-08 | 159,00 € |

Suture Needles

Polished stainless steel
3/8 curved
Round with standard eye
Diameter 0.35 mm
Non-sterile

Pkg. of 12 needles

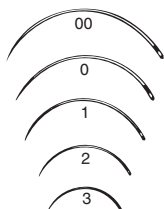

| Size | Item | Price |
|------|--------------|---------|
| 00 | No. 12050-20 | 18,50 € |
| 0 | No. 12050-10 | 18,50 € |
| 1 | No. 12050-01 | 18,50 € |
| 2 | No. 12050-02 | 18,50 € |
| 3 | No. 12050-03 | 18,50 € |

Silk Suture

Silk suture has a smooth flow through tissue while maintaining knot security.

Braided silk

Non-sterile



**NEW
ITEM**

| Size | Diameter (mm) | Spool length (m) | Item | Price |
|------|---------------|------------------|--------------|---------|
| 7/0 | 0.05 | 91 | No. 18020-70 | 63,00 € |
| 6/0 | 0.08 | 23 | No. 18020-60 | 32,50 € |
| 5/0 | 0.12 | 23 | No. 18020-50 | 33,50 € |
| 4/0 | 0.17 | 23 | No. 18020-40 | 35,00 € |
| 3/0 | 0.22 | 23 | No. 18020-30 | 37,00 € |
| 2/0 | 0.32 | 23 | No. 18020-20 | 41,50 € |
| 0 | 0.37 | 23 | No. 18020-00 | 49,50 € |
| 1 | 0.45 | 23 | No. 18020-01 | 49,50 € |
| 2 | 0.55 | 23 | No. 18020-02 | 70,50 € |
| 3 | 0.65 | 23 | No. 18020-03 | 71,50 € |

SUTURES

For Suture Tying Forceps, see pages 76 and 77.

Nylon Monofilament Suture

Nylon is known for its uniform diameter flexibility and outstanding consistent knot security.

Nylon monofilament

Non-sterile



**NEW
ITEM**

| Size | Diameter (mm) | Spool length (m) | Item | Price |
|------|---------------|------------------|--------------|----------|
| 8/0 | 0.04 | 91 | No. 18030-80 | 107,00 € |
| 7/0 | 0.05 | 91 | No. 18030-70 | 64,00 € |
| 6/0 | 0.07 | 91 | No. 18030-60 | 102,00 € |
| 5/0 | 0.10 | 91 | No. 18030-50 | 102,00 € |
| 4/0 | 0.15 | 91 | No. 18030-40 | 90,00 € |
| 3/0 | 0.20 | 91 | No. 18030-30 | 76,00 € |

Michel Suture Clips

Anti-magnetic, acid-resistant stainless steel
Pkg. of 1,000 clips

| Size (mm) | Item | Price |
|------------|--------------|---------|
| 7.5 x 1.75 | No. 12040-01 | 72,00 € |
| 11 x 2 | No. 12040-02 | 67,00 € |
| 12 x 2.5 | No. 12040-03 | 67,00 € |

Larger clip sizes also available.

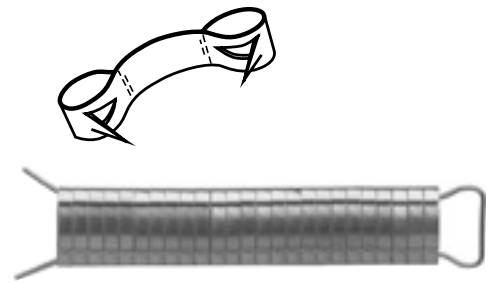

Applying Forceps



For all Michel suture clips
12.5 cm

No. 12018-12
30,50 €

Applying and Removing Instruments



For clip size 12040-01 only
Angled
13 cm

No. 12029-12
100,00 €



For clip sizes
12040-02 and larger
Curved
13 cm

No. 12028-12
63,00 €



Suturing Principles and Techniques in Laboratory Animals

Introduces the basic principles, materials and surgical instruments required for suturing and wound closure used on animals. The manual provides descriptions and pictures portraying proper tissue handling and aseptic technique, correct hand placement and use of surgical instruments, proper needle placement on needle holders, and provides an in-depth explanation of various suture patterns and associated principles for proper knot tying during wound closure.

The DVD provides descriptive narrative and step-by-step video demonstrations for each of the suturing techniques.

Manual and DVD

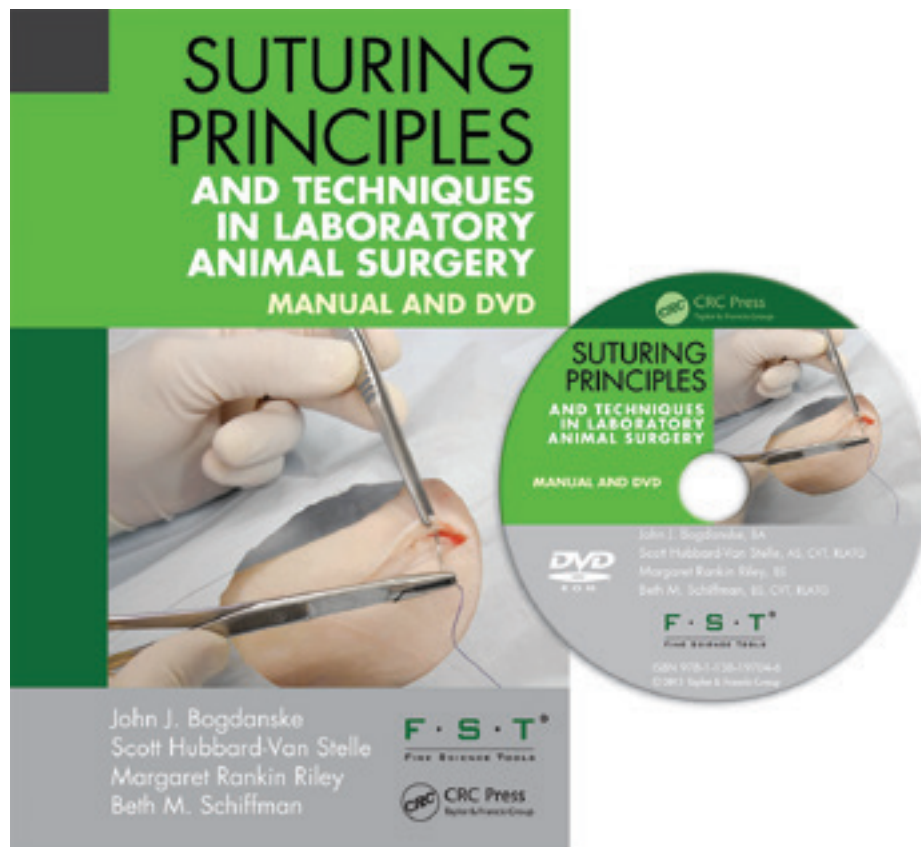

Includes: Fine Science Tools Item Number
Reference Page for all surgical instruments
used in the manual.

No. 23005-10
66,00 €

Reloadable Skin Stapler with Rotating Head

The 360° degree swivel nose and unique design offers maximum visibility at the delivery point. The stainless steel staples are non-sterile and feature the patented "Twin Towers" staple design which make for quick and easy removal. The disposable staple cartridge includes a printed staple counter. **The handle is reusable and autoclavable. Staples are non-sterile. Components sold separately or as a kit.**

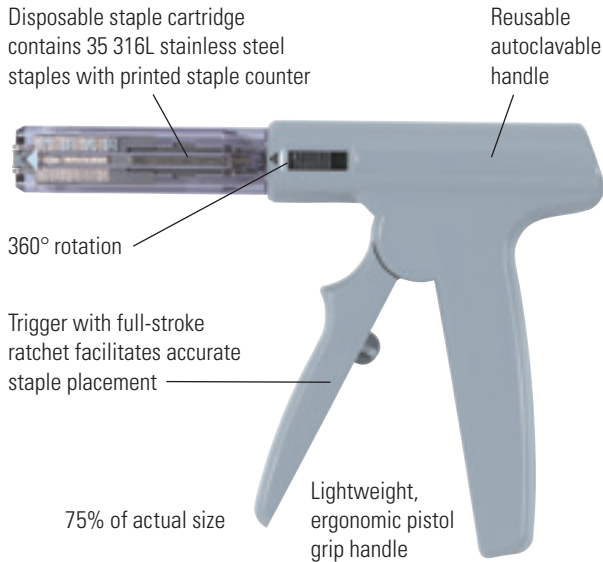

Surgical staple kit
 • 1 Handle
 • 1 Remover
 • 12 Disposable staple cartridges
No. 12030-20
 159,50 €

Single disposable cartridge
 35 staples per cartridge
No. 12030-22
 12,50 €

12 disposable cartridges
 35 staples per cartridge
No. 12030-23
 132,00 €

Handle
No. 12030-01
 20,00 €

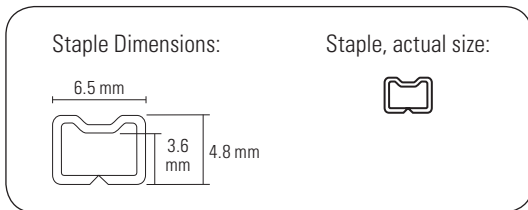

Surgical Staple Remover

Compatible with Reloadable Skin Stapler with Rotating Head and Manipler® Skin Stapler.



75% of actual size

10 cm
No. 12030-04
 11,00 €

SKIN STAPLERS

Manipler® Skin Stapler

Quality, slim, lightweight design with consistent actuation and staple count indicator. **Disposable, sterile, and not autoclavable.**

15 cm
 35 staples per cartridge
No. 12035-00
 15,00 €

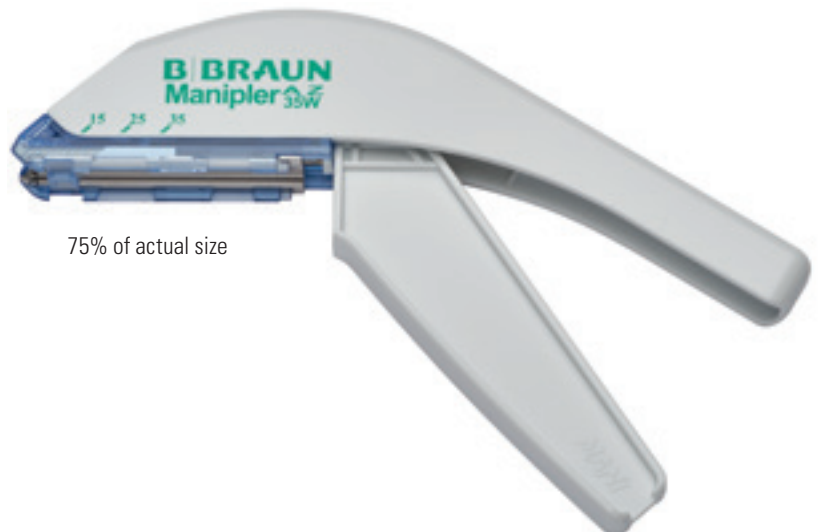

75% of actual size

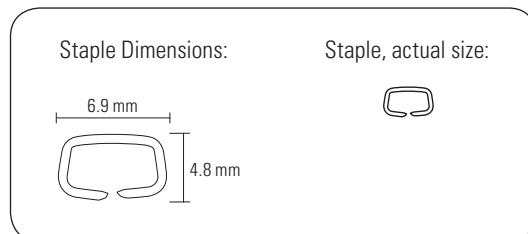

AutoClip® System

The AutoClip® System is a safe, secure method of wound closure. Faster and easier than suture, this system is perfect when staples may be too thin to provide adequate closure. **Non-sterile and not autoclavable. Components sold separately or as a kit.**

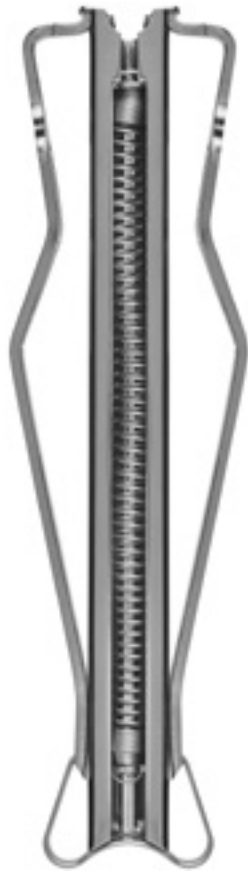

Applier



Clips



Remover

AutoClip® Kit

- 1 Applier
- 9 mm clips (100)
- 1 Remover
- Storage case

No. 12020-00
352,50 €

AutoClip® applier
11.5 cm

No. 12020-09
230,50 €

AutoClip® 9 mm clips
Pkg. of 100 clips

No. 12022-09
31,00 €

AutoClip® remover
12.5 cm

No. 12023-00
132,00 €

Guthrie

Extra delicate pattern.

2.5 mm



2 Pronged
Blunt
13 cm

No. 17021-13
63,00 €

6 mm



2 Pronged
Blunt
13.5 cm

No. 17023-13
43,50 €

Blair

6 mm



4 Pronged
Blunt
13.5 cm

No. 17022-13
60,50 €

Fomon

13 mm



2 Pronged
2 mm Ball at each tip
17 cm

No. 17020-17
77,00 €

Slide Retractor with Blades



Maximum spread: 1 cm
Atraumatic blades
2 cm

No. 17004-03
128,00 €

Mini-Goldstein

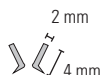

Maximum spread: 0.5 cm
3x3 Sharp teeth
2 cm

No. 17002-02
109,50 €

Mini-Colibri



**NEW
ITEM**



Maximum spread: 1 cm
2 cm

No. 17000-01
29,00 €

RETRACTORS

Slide Retractor with Teeth



Maximum spread: 1 cm
2x2 Blunt teeth
2 cm

No. 17005-03
119,50 €

Goldstein

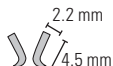
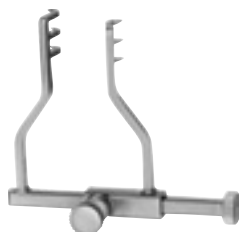

Maximum spread: 1.8 cm
3x3 Sharp teeth
3 cm

No. 17003-03
70,50 €

Colibri

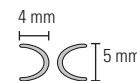

Maximum spread: 1.5 cm

Maximum spread: 1.2 cm

3 cm
No. 17000-03
22,00 €

**MOST
POPULAR**

3 cm
No. 17000-02
20,50 €

4 cm
No. 17000-04
21,50 €

Fine Adjustable Wire Retractor



Thin, curved blades
Maximum spread: 3.5 cm
5 cm

No. 17004-05
126,50 €

Agricola

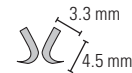

Maximum spread: 3.5 cm
3x3 Sharp teeth
4 cm

No. 17005-04
88,50 €

Spring-Loaded Retractor



Curved atraumatic blades

Maximum spread: 3 cm
Blade dimensions: 14 x 10 mm
5.5 cm

No. 17006-05
36,00 €

Maximum spread: 4 cm
Blade dimensions: 22 x 16 mm
8 cm

No. 17007-08
37,00 €

Speculum

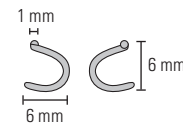

Thin, curved blades and grooved finger grips
Maximum spread: 3.5 cm
4.5 cm

Moria 7699
No. 17370-53
62,50 €



Alm Retractor with Wire Teeth



**NEW
ITEM**

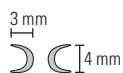

Maximum spread: 4 cm
Arms gently curved down
7 cm

No. 17010-07
89,00 €

Alm Retractor with Blunt Teeth



Maximum spread: 4 cm
Arms gently curved down
7 cm



Blunt teeth
No. 17008-07
81,50 €

**MOST
POPULAR**

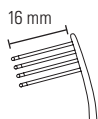

Long blunt teeth
No. 17009-07
95,00 €

Alm Retractor with Blades

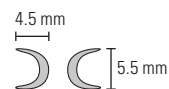

Maximum spread: 4.5 cm
Arms gently curved down
7.5 cm

No. 17009-08
104,50 €

RETRACTORS

**Alm Retractor
for Three Point Retraction**



Movable third arm with curved ends fits left or right

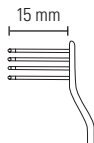

Maximum spread: 7 cm
Arms curved down
Long blunt teeth
Range: 30 mm
Depth: 15 mm
10 cm

No. 17010-10
150,00 €

Bowman



Maximum spread: 2.5 cm
8 cm

No. 17001-07
18,50 €

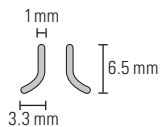
Heiss

Maximum spread: 2.3 cm
 4x4 Blunt teeth
 10 cm

No. 17011-10
 84,50 €

Gelpi

Maximum spread: 3 cm
 Angled down
 1x1 Sharp teeth
 10 cm

No. 17017-10
 147,00 €

Weitlaner-Locktite

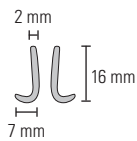

Maximum spread: 4.5 cm
2x3 Blunt teeth
11 cm
No. 17012-11
136,50 €

Maximum spread: 6.5 cm
3x4 Blunt teeth
13 cm
No. 17012-13
138,50 €

Wullstein

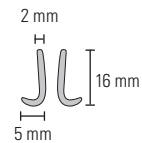
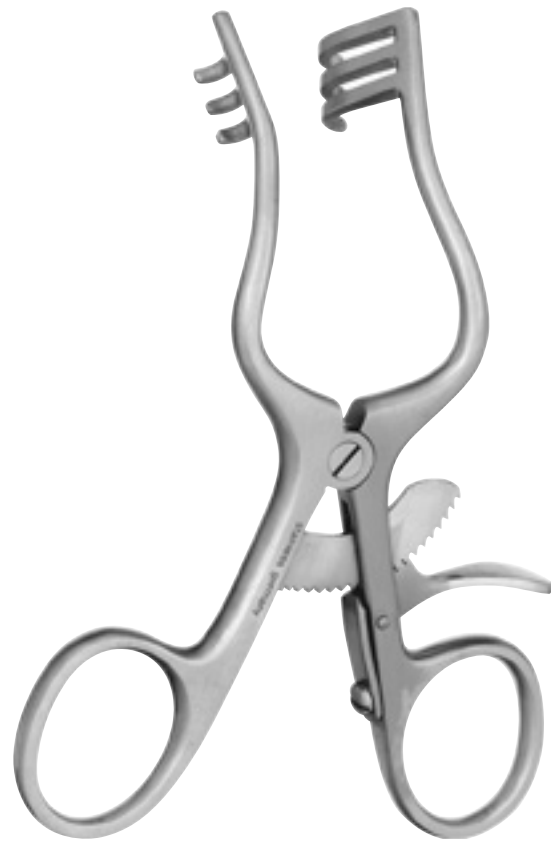

Maximum spread: 4.5 cm
Angled down
3x3 Blunt teeth
11 cm

No. 17018-11
177,00 €

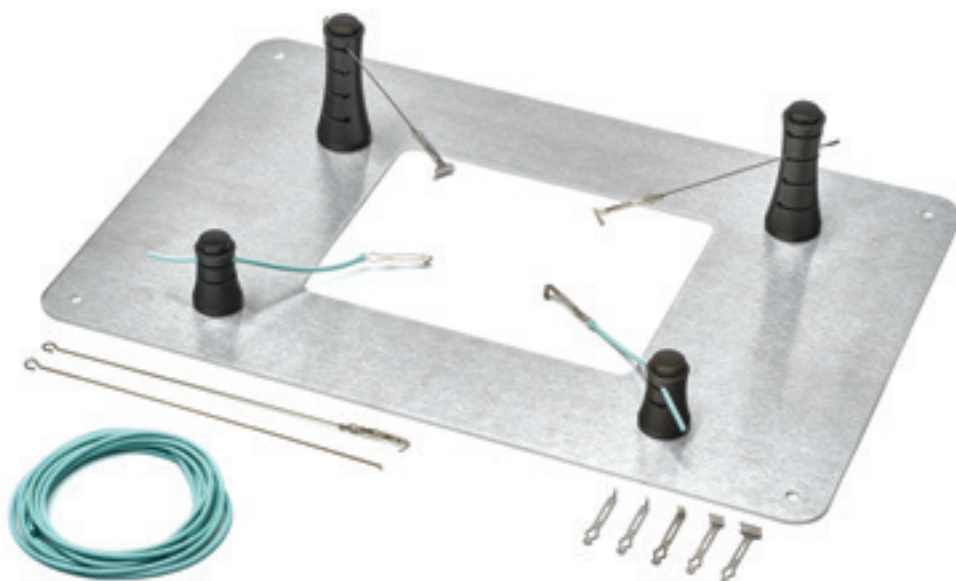

Magnetic Fixator Retraction System

This Small Animal Retraction System simplifies set-up procedure and provides the examiner with an excellent overview of the operative site. It consists of three components: **Base Plate** (Nos. 18200-03 & 18200-04); **Fixators** (Nos. 18200-01 & 18200-02); and **Retractors** (Nos. 18200-05 through 18200-12).

The **Base Plates** are made from magnetic stainless steel and are available in two sizes. The surface is nonreflective and both plates have a window in the center which allows the animal contact with body temperature control systems. The window sizes are 10 x 13 cm for the small base plate and 15 x 25 cm for the large.

The **Fixators** are movable anchors made from anodized aluminum with a surgical grade rare earth magnet in the base for attachment anywhere on the Base Plate. The magnets do not interfere with lab electronics and can be used in close proximity (3 cm) to ferro-magnetic items. They incorporate pushbutton-activated spring locks that grip either the Wire or Elastomer Retractors.

The **Retractors** are interchangeable Retractor Tips (Nos. 18200-08 through 18200-12) which attach to either Retractor Wire (Nos. 18200-05 & 18200-06) for static retraction or to Elastomer (No. 18200-07) for dynamic retraction. The Retractor Tips are light and atraumatic to delicate tissue or membrane.

All system components are autoclavable.

Kit for animals up to 200 g

Includes:

- 1 Small base plate (No. 18200-03)
- 2 Short fixators (No. 18200-01)
- 1 Tall fixator (No. 18200-02)
- 1 Elastomer, 2 m roll (No. 18200-07)
- 1 Package of retractors, blunt, 1 mm wide (No. 18200-09)
- 1 Package of retractors, blunt, 2.5 mm wide (No. 18200-10)

No substitutions

No. 18200-20
238,50 €

**MOST
POPULAR**

Kit for animals from 200 g up to 5 kg

Includes:

- 1 Large base plate (No. 18200-04)
- 2 Short fixators (No. 18200-01)
- 2 Tall fixators (No. 18200-02)
- 1 Elastomer, 2 m roll (No. 18200-07)
- 1 Package of retractors, blunt, 2.5 mm wide (No. 18200-10)
- 1 Package of retractors, blunt, 5 mm wide (No. 18200-11)

No substitutions

No. 18200-50
294,00 €

Individual parts:

Short fixator, 2.5 cm high
Each
No. 18200-01
42,00 €

Tall fixator, 5 cm high
Each
No. 18200-02
59,00 €

Small base plate, (20 x 30 cm)
Each
No. 18200-03
54,50 €

Large base plate, (25 x 35 cm)
Each
No. 18200-04
61,50 €

Wire handles, 10 cm long
Pkg. of 10
No. 18200-05
21,00 €

Wire handles, 14 cm long
Pkg. of 10
No. 18200-06
22,50 €

Elastomer, 2 m roll
No. 18200-07
22,50 €

Sharp retractors
Pkg. of 10
No. 18200-08
29,00 €

Blunt retractors, 1 mm wide
Pkg. of 10
No. 18200-09
29,00 €

Blunt retractors, 2.5 mm wide
Pkg. of 10
No. 18200-10
29,00 €

Blunt retractors, 5 mm wide
Pkg. of 10
No. 18200-11
29,00 €

Blunt retractors, 7.5 mm wide
Pkg. of 10
No. 18200-12
29,00 €

Clamp Size and Clamp Pressure

Clamp pressure is determined by the closing force of the clamp (in grams), divided by the area of the vessel wall that is compressed between the jaws (in square millimeters). Thus, the smaller the vessel, the higher the pressure exerted.

Despite the wide range of closing forces, the pressure exerted by each clamp, big or small, remains consistent throughout the series. Each size of clamp exerts a pressure of 5g/mm² when used on the largest vessel in its range, and 15g/mm² when used on the smallest vessel. Even at the higher range, S&T's micro clamps have the gentlest working pressure of any small vessel clamp available.

| Clamp (ea) | L x W (mm) | Vessel Diameter Range (mm) |
|---------------------|------------|----------------------------|
| 00396-01 & 18040-11 | 3.5 x 1.0 | 0.4 - 1.0 ◦ ◦ |
| 00398-02 & 18040-22 | 5.5 x 1.5 | 0.6 - 1.5 ◦ ◦ |
| 00400-03 & 18040-33 | 7.5 x 1.75 | 1.0 - 2.25 ◦ ◯ |
| 00325-00 | 10 x 2.15 | 2.0 - 5.0 ◦ ◯ |

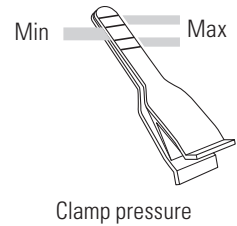
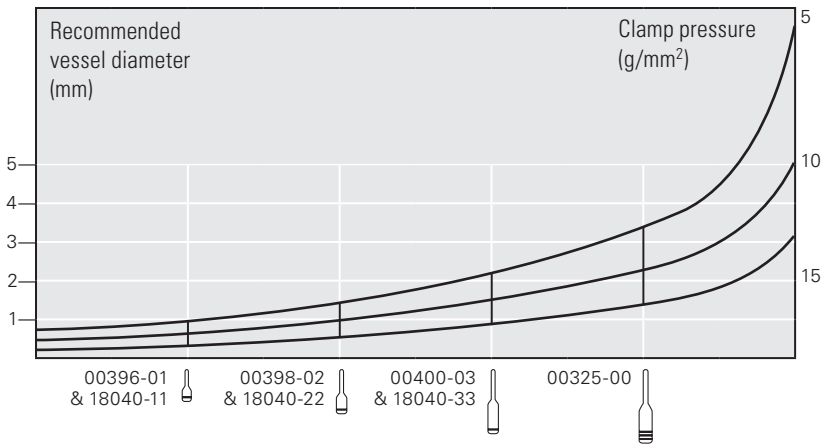

See page 131 for Micro Clamp and Double Clamp Appliers.

MICRO CLAMPS

Micro Clamps S&T®



S&T B-1
No. 00396-01
61,00 €



S&T B-2
No. 00398-02
58,00 €



S&T B-3
No. 00400-03
56,50 €



S&T HD-S
No. 00325-00
90,50 €

Double Micro Clamps

For vascular approximation at anastomosis. These clamps are mounted on a 10 mm sliding bar and can easily be moved by applying gentle force. The distance between the jaws of the clamps is adjustable from 3 to 16 mm.



No. 18040-11
244,00 €



No. 18040-22
240,00 €



No. 18040-33
231,00 €

Micro Clamp Applying Forceps



S&T®

Only compatible with
S&T Micro Clamps
14 cm

With lock
No. 00071-14
113,50 €

Without lock
No. 00072-14
85,00 €

Micro Clamp Applying Forceps

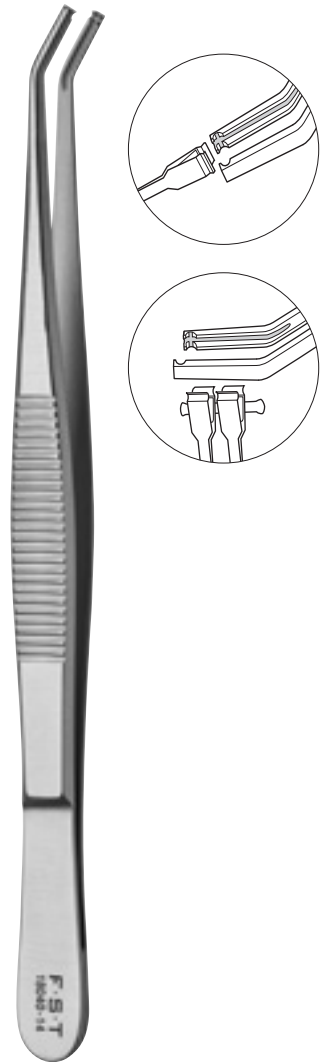

Compatible with S&T
Micro Clamps and
Double Micro Clamps
14.5 cm

No. 18040-14
122,50 €

Micro Clip Applicator with Lock



For use with our 18055 series micro serrefines 14 cm

No. 18056-14
323,00 €

Forceps Style Clip Applicator

This applicator features special U-shaped side supports for improved seating of the clips.



For use with our 18055 series micro serrefines 14 cm

No. 18057-14
50,00 €

Stainless Steel Micro Serrefines

Used to obtain a clear surgical field for extended arterial cross-clamping.

Delicate atraumatic serrations
Spring width: 2 mm



45,00 €

| | No. 18055-01 | -02 | -03 | -04 |
|-------------------|--------------|-----|-----|------|
| Jaw length (mm) | 10 | 8 | 6 | 4 |
| Jaw width (mm) | 2 | 2 | 1 | 0.75 |
| Total length (mm) | 19 | 16 | 15 | 13 |
| Jaw pressure (g) | 60 | 85 | 100 | 125 |



54,00 €

| | No. 18055-05 | -06 |
|-------------------|--------------|------|
| Jaw length (mm) | 6 | 4 |
| Jaw width (mm) | 1 | 0.75 |
| Total length (mm) | 17 | 16 |
| Jaw pressure (g) | 100 | 125 |

Titanium Micro Serrefines

• TITANIUM •

Lightweight with strong clamping pressure.

For more information on Titanium see page 183.

Delicate atraumatic serrations
Spring width: 2 mm



98,00 €

| | No. 18555-01 | -02 | -03 | -04 |
|-------------------|--------------|-----|-----|------|
| Jaw length (mm) | 10 | 8 | 6 | 4 |
| Jaw width (mm) | 2 | 2 | 1 | 0.75 |
| Total length (mm) | 19 | 16 | 15 | 13 |
| Jaw pressure (g) | 60 | 85 | 100 | 125 |

Cautionary note: Micro Serrefines should never be compressed with fingers; use only the appropriate applicator No. 18056-14 or No. 18057-14.

Moria Vessel Clamp

Finely serrated (atraumatic)
Light pressure
For vessels up to 2 mm in diameter
Calibrated to 15g/mm²
1.8 mm wide, 3 cm long
Straight
33 mm



Moria 201/A
No. 18320-11
31,00 €



Moria Bulldog Type Clamps

Non-serrated
Strong pressure
2 mm wide
53 mm



Straight
Moria MC43
No. 18374-43
88,50 €



Curved
Moria MC44
No. 18374-44
88,50 €



Dietrich Bulldog Clamps

Serrated
Good access to deep seated vessels
Closing pressure: 50 g (light)
Weight: 3 g



Straight
52.5 mm
No. 18038-45
131,50 €



Angled
50 mm
No. 18039-45
142,50 €

Bulldog Type Serrefines

Serrated

Straight
Medium pressure
28 mm
No. 18050-28
48,00 €



Curved
Medium pressure
28 mm
No. 18051-28
51,00 €



Straight
Strong pressure
35 mm
No. 18050-35
39,50 €



Straight
Strong pressure
50 mm
No. 18050-50
33,50 €



Curved
Strong pressure
35 mm
No. 18051-35
39,50 €

Curved
Strong pressure
50 mm
No. 18051-50
33,50 €

Schwartz Micro Serrefines

Non-serrated
Strong pressure
26 mm

MOST POPULAR

Straight
No. 18052-01
9,50 €



Light bend
No. 18052-02
10,00 €



Sharp bend
No. 18052-03
10,00 €



Mini Serrefines

Smallest bulldog-type hemostatic clamps
Medium pressure
Gentle serrations
2 mm wide
28 mm

Straight
No. 18054-28
65,50 €



Curved
No. 18053-28
68,50 €



Bulldog Artery Spring Clamp

Can be used with a minimum of distortion for MRI investigations.

Straight
Serrated
Light pressure
30 mm



TITANIUM

No. 18144-30
233,00 €

For more information on Titanium see page 183.



Silver Neuro Clips

These single-use, silver neuro clips are meant for permanent vessel occlusion.

Pkg. of 100 clips
No. 18040-00
56,00 €

Vascular Occluders

Applications

- Fast, dependable zero-flow baseline determination in blood flow studies.
- Partial to full occlusion of vessels for circulation research studies.
- Prolonged implantations, such as chronic blood flow studies.
- Constriction of soft organs in acute or chronic applications.

Operation

- Step 1** Apply the occluder cuff around the exposed blood vessel. Secure it in place with suture material through the eyelets.
- Step 2** Occlude the vessel to the desired degree by inflating the diaphragm with air or liquid injected into the actuating tube using a syringe and blunt needle. Clamp the tubing to maintain occlusion of the vessel over time.
- Step 3** To deflate, simply withdraw the air or liquid.

Benefits

- Occlusion is accomplished without traction on vessels or surrounding tissues.
- The actuating tube may be exteriorized from the occlusion site for remote actuation.
- Performance during implantations is reliable and consistent.
- Autoclavable or cold sterilized, and easily maintained.
- Made from soft, flexible 100% silicone rubber.
- Fully operational with instant response using air, liquids, or inert gases.

Selection

The lumen diameter when deflated is usually the determining factor in the selection of the proper device. Select the occluder size that provides a slightly loose fit around the subject vessel. The cuff width and thickness will vary, depending on models and sizes.

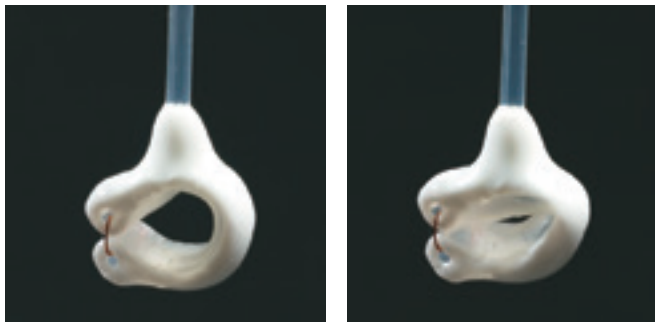

The actuating tube length is 90 cm and measures 0.76 mm ID x 1.6 mm OD. Detailed instructions are included.

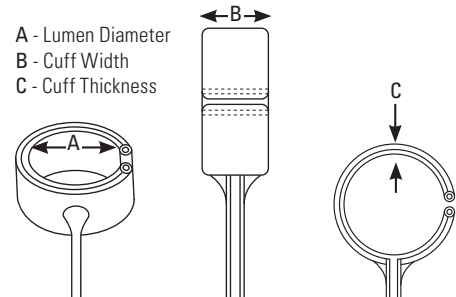

VO-1.5 N

Lumen diameter: 1.5 mm
Cuff width: <3.5 mm
Cuff thickness: 1.5 mm

No. 18080-01
127,00 €

VO-2

Lumen diameter: 2 mm
Cuff width: 5 mm
Cuff thickness: 1.5 mm

No. 18080-02
160,00 €

VO-3

Lumen diameter: 3 mm
Cuff width: 5 mm
Cuff thickness: 1.5 mm

No. 18080-03
126,50 €

V-Hook

Aids in feeding fine suture around blood vessels, works very similar to ligation aids.



Tip diameter: 0.4 x 0.2 mm
11 cm

No. 18052-12
111,50 €

Ligation Aids

A handy instrument for leading a fine suture under and around a blood vessel for tying-off purposes. Also useful for ligating peripheral nerves. Grooves toward hole help threading.



Ultrafine
Hole diameter: 0.4 mm
10.5 cm

No. 18062-12
101,00 €



Hole diameter: 1 mm
13.5 cm

No. 18062-13
46,50 €



Hole diameter: 1 mm
13.5 cm

No. 18063-13
46,00 €

Vessel Dilators

Highly modified forceps with elongated, parallel tips which are highly polished. Designed for controlled intraluminal vessel dilation.

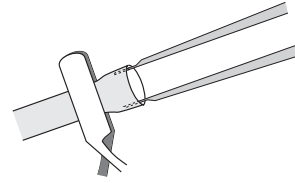

DILATORS



S&T®

Angled 10°
11 cm

Tip diameter: 0.1 mm
No. 00126-11
223,00 €

Tip diameter: 0.2 mm
No. 00125-11
199,50 €



S&T®

Angled 45°
Tip diameter: 0.2 mm
13.5 cm

No. 00276-13
195,00 €



Angled 10°
12 cm

Tip diameter: 0.1 mm
No. 18131-12
186,50 €

Tip diameter: 0.2 mm
No. 18132-12
183,00 €

Tip diameter: 0.3 mm
No. 18133-12
178,00 €

Balanced Instruments

Balanced instruments are designed to put the center of gravity between the thumb and index finger. This is accomplished by adding a slight counter weight to the proximal end of the instruments. The design enhances tactile feel, aiding in better control and precision.

Vessel Dilators

The tips of these multipurpose forceps are configured to enable their use as dilators at the front, as well as needle holders and tying forceps further in the back. The platform at the tips close parallel ensuring a reliable grip.

Vessel Dilator



86% of actual size



Straight
Suture tying platform
Tip diameter: 0.1 mm
14.5 cm

No. 18601-15
301,00 €



86% of actual size



Straight
Suture tying platform
Tip diameter: 0.3 mm
15 cm

No. 18602-15
291,00 €



86% of actual size



Angled
Smooth
Tip diameter: 0.2 mm
14.5 cm

No. 18603-14
245,00 €

Micro Cannulation System

This micro cannula is most helpful for quick and easy insertion in arteries and veins. It can be used as an “indwelling” catheter during long term experiments. With care, thorough rinsing and sterilization, it can be reused several times. Detailed instructions are included.



Features

- Biocompatible Teflon® tubing.
- Cannula size 0.33 mm OD – 0.16 mm ID
- A pointed stainless steel stylus (trocar), to aid in vascular penetration and allow a maximum range of cannula manipulation during insertion.
- Contoured tip for easy insertion, fitted with shoulder for “tie-in” to prevent accidental removal.
- Female luer connection for linkage to infusion lines.

8 cm

No. 18000-10

58,00 €

1. Approach

Cannulation Forceps (Item No. 18403-11) and Spinal Cord Hook (Item No. 10162-12) aid in the insertion process.

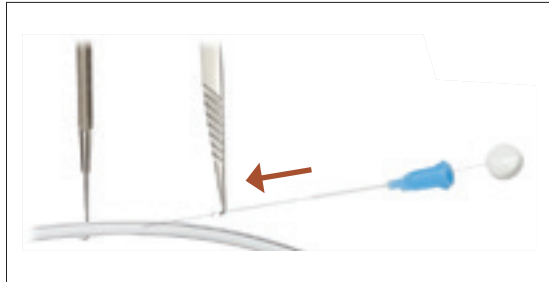

2. Insertion

Remove trocar and advance cannula.

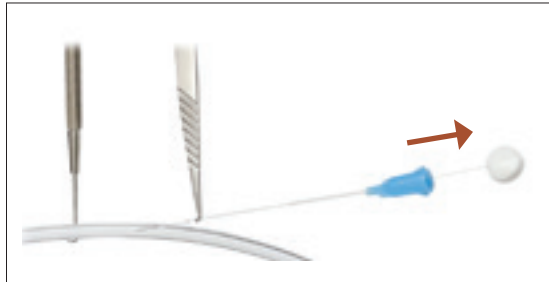

3. Secure

Use shoulder hub and suture to “tie in” cannula to prevent accidental removal.



Instruments sold separately.

Vessel Cannulation Forceps

These vessel cannulation forceps are useful whenever a fine plastic tube has to be introduced into a small blood vessel of almost equal size. The hollowed jaws hold the tubing securely without deforming it. The tip of the tubing is directed exactly into the vessel opening without damage to the vessel from unwanted movement.

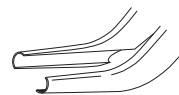

For tubing between
0.5 and 1 mm OD

11 cm
No. 00574-11
160,00 €

13.5 cm
No. 00571-13
137,00 €

S&T[®]



For tubing of 0.35 mm OD
11 cm
No. 11280-11
189,50 €

For tubing of 0.5 mm OD
11 cm
No. 11281-11
206,00 €

For tubing of 1 mm OD
11 cm
No. 11282-11
169,50 €

DUMONT⁺
S W I S S M A D E



For tubing of 0.35 mm OD
11.5 cm
No. 18403-11
166,00 €

For tubing of 0.6 mm OD
11.5 cm
No. 18406-11
162,00 €

For tubing of 0.6 mm OD
13.5 cm
No. 18406-13
109,00 €



Surgical & Laboratory Accessories

| | | |
|-------------------------------|-------|-----------|
| Animal Accessories | Pages | 141 – 143 |
| Instrument Care & Accessories | Pages | 144 – 155 |
| Surgical Accessories | Pages | 156 – 159 |
| Laboratory Accessories | Pages | 160 – 171 |



Reusable Gavage Feeding Needles

Stainless steel feeding needles with luer lock hub. Also ideal for transcardiac perfusions with a fixative.

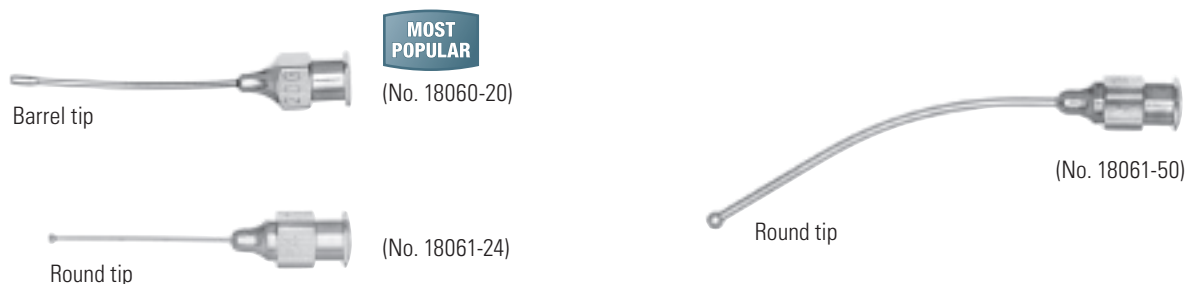

| Gauge | Length (mm) | Tip diameter (mm) | Shape | Mice | Rats | Guinea pigs | Item | Price |
|-------|-------------|-------------------|----------|---------|-----------|-------------|--------------|---------|
| 24 | 25 | 1.25 | Straight | >14 g | | | No. 18061-24 | 53,00 € |
| 22 | 25 | 1.25 | Straight | 15-20 g | | | No. 18061-22 | 47,50 € |
| 20 | 30 | Barrel | Straight | 20-25 g | | 50-75 g | No. 18060-20 | 31,00 € |
| 18 | 50 | 2.25 | Curved | 25-30 g | 100-200 g | 250-300 g | No. 18061-50 | 36,50 € |
| 16 | 75 | 3.00 | Curved | | 150-300 g | 350-450 g | No. 18061-75 | 37,00 € |
| 16 | 100 | 3.00 | Curved | | 150-300 g | 350-450 g | No. 18061-10 | 37,50 € |

Single Use Gavage Feeding Needles

These economical feeding needles feature plastic luer hubs with silicone tips. They are nontoxic and nonpyrogenic. Needles can be easily formed to any desired shape. **Sterile.**



Pkg. of 5 needles

| Gauge | Length (mm) | Tip diameter (mm) | Shape | Mice | Rats | Guinea pigs | Item | Price |
|-------|-------------|-------------------|----------|---------|-----------|-------------|--------------|---------|
| 20 | 38 | 1.75 | Flexible | 20-25 g | 50-75 g | | No. 18061-20 | 35,00 € |
| 18 | 50 | 2.50 | Flexible | 25-30 g | 100-200 g | | No. 18061-18 | 35,00 € |
| 15 | 75 | 3.00 | Flexible | | 200-350 g | 400-600 g | No. 18061-15 | 35,00 € |

GenoPunch

The interchangeable GenoPunch aids in the fast and simple collection of the 2 mm tissue sample for DNA analysis and/or genotyping. FST Exclusive Item. **Autoclavable.**



80% of actual size

GenoPunch includes:

- 1 GenoPunch
- 1 0.5 ml tube holder
- 1 1.6 ml tube holder
- 1 Screwdriver
- 4 Screws



FST does not supply microtubes.

Stainless steel and anodized aluminum
Punch diameter: 2 mm
11.5 cm

No. 24215-02
101,00 €

Ear Punch

Designed to ensure a fast and clean punch, this ear punch is lightweight and fits comfortably in the palm of your hand. FST Exclusive Item. **Autoclavable.**



80% of actual size

Stainless steel and
anodized aluminum
Punch diameter: 2 mm
11.5 cm

No. 24214-02
68,50 €

Finger Loop Ear Punch

This ear punch provides stability and control for researchers using the numbering system. The 1 mm ear punch offers greater numbering variations and/or patterns.



80% of actual size

10.5 cm

Punch diameter: 1 mm
No. 24212-01
37,00 €

Punch diameter: 2 mm
No. 24212-02
32,50 €

Self Piercing Ear Tags

Ideal for use in small animals such as mice and rats, these ear tags come numbered from 1-100 or 1-500. Silver colored tags with black numbers provide high visibility making them easy to read. Once applied, tags seal and cannot be removed, providing an easy to use, permanent identification method. These ear tags are safe for use in salt water.



Ear tags
Alloy: Monel
7.8 x 2.8 mm

Black numbers 1-100
No. 24220-10
25,00 €

Black numbers 1-500
No. 24220-50
112,50 €



Ear Tags (enlarged view)

Custom alphanumeric sequences and numbers above 500 are available by special order.

Clips are slightly bigger, made of brass, and golden colour. Special applicator item No. 24230-00 at 82,00 € needed.

Front side: 4 digits serially numbered
Back side: up to 3 fixed digits/numbers

For prices, please contact us at europe@finescience.de or call +49 (0) 62 21 - 90 50 50.



80% of actual size

Applicator
Stainless steel
14 cm

No. 24220-00
58,50 €

Animal Microtattoo System

A quick, efficient and affordable method of permanently identifying laboratory animals (mice as early as 1 day old). Designed and tested by laboratory animal technicians, the system utilizes a hypodermic needle at one end of a stainless steel forceps and a small metal cup containing green tattoo paste at the other side of the forceps.

By squeezing the forceps together, the needle penetrates the toe, footpad or ear of the animal and injects a deposit of green tattoo paste into the animal. A grid location pattern provided enables a numbering system that extends over 1 million.

Use of the microtattoo system is humane and in compliance with regulatory agencies for the care and use of laboratory animals. Detailed instructions are included. **Both the microtattoo forceps and green tattoo paste are autoclavable.**

Animal microtattoo system includes:

- 1 Pair plated steel microtattoo forceps
- 1 Tube (1 oz.) of green tattoo paste
- 1 Aluminum planchette
- 2 Hypodermic needles
- 1 Plastic holding case



55% of actual size

Animal microtattoo system
13 cm

No. 24201-00
385,00 €



Green tattoo paste
1 oz

No. 24201-01
9,50 €



Silicone Seal and Lubricant

This stiff non-melting silicone base maintains its consistency from -40°C to 200°C (40°F to 392°F) with less than 2% evaporation after 24 hours of exposure to 150°C (302°F). Typical applications include lubrication of stopcock rotating parts and other lab items. Seals vacuum and low pressure systems. Compatible with glass, plastics, metals, synthetic rubber gaskets and seals. **Autoclavable.**

15 ml container
No. 29051-45
9,50 €

Demagnetizer

This safe and easy to operate tabletop demagnetizer has a large coil opening of 8 x 4 cm in a rigid, molded housing. Can be used to demagnetize or magnetize instruments.

12 x 5.5 x 9 cm

No. 18000-15
76,00 €



European version differs from photo.

Instrument Sharpening Stones

Natural Arkansas oil stones feature unequaled fineness, hardness and structural density. When used with mineral oil, they will produce a sharper cutting edge.

6 mm x 9 cm

Square stone
No. 29008-01
15,00 €

Triangular stone
No. 29008-12
15,00 €

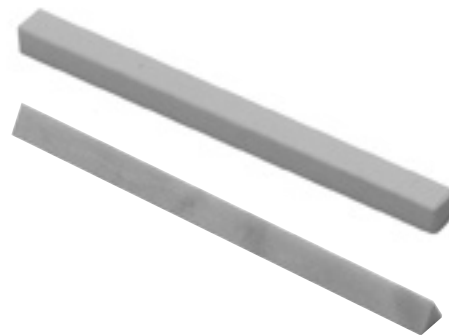

Instrument Oil and Oil Pen

Physiologically inert oil for lubricating surgical instruments, box locks, ratchets and any overlapping joints. Oil pen is refillable.

50 ml bottle
No. 29055-00
10,00 €



7 mm needle
12.5 cm

12 ml oil pen
No. 29055-12
9,50 €



Sharpening Stone for Fine Forceps

This natural Arkansas stone assists in reshaping the tips of fine forceps. The stone has two grooves, 0.8 mm and 1.6 mm, and comes in a cedar box with ten O-rings.

4 x 1 x 10 cm

No. 29008-22
43,00 €



Fine Forceps Repair Kit

Realign and repair fine forceps with this convenient kit. Bent forceps tips can be restraightened with the chain nose pliers. The sharpening stone has two grooves, 1.6 mm and 0.8 mm, to assist in reshaping the forceps tips. O-rings clamp the forceps shut to ensure that both shanks are equally aligned and sharpened. Instrument oil assists in producing a smooth sharp edge. Detailed instructions are included.

Kit includes:

- 1 Sharpening stone for fine forceps with ten O-rings (No. 29008-22)
- 1 Instrument oil, 50 ml bottle (No. 29055-00)
- 1 Chain nose pliers

No. 29000-00
74,00 €

**MOST
POPULAR**

Optical Cleaning Kit and Lens Paper

This convenient kit contains everything you need to clean lens surfaces safely. Perfect for microscopes, camera lenses, binoculars, telescopes, graphic art optics, and all other fragile lenses. Storage case included.

Kit includes:

- 1 Bottle of lens cleaner (30 ml)
- 1 Ultra soft duster brush
- 1 Cleaning cloth (20 x 20 cm)
- 3 Books of lens paper (25 sheets each)

Kit
No. 29000-10
33,50 €

Lens Paper
15 x 10 cm
Book of 50 sheets
No. 29015-50
5,50 €



Instrument Marking Tape

Organize instruments quickly and easily with this economical, non-toxic, pressure sensitive tape. Color is unaffected by boiling, cold sterilization or autoclaving. 8 colors available. **Autoclavable.**

Material: Vinyl
290 x 0.6 cm (each roll)



Green
No. 29071-01
11,00 €



Blue
No. 29071-02
11,00 €



Yellow
No. 29071-03
11,00 €



Red
No. 29071-04
11,00 €



White
No. 29071-05
11,00 €



Black
No. 29071-06
11,00 €



Brown
No. 29071-07
11,00 €



Orange
No. 29071-08
11,00 €

Instrument Marking Tape 8 Assorted Colors

Organize instruments quickly and easily with this economical, non-toxic, pressure sensitive tape. Color is unaffected by boiling, cold sterilization or autoclaving. Includes 8 assorted color rolls: Yellow, Red, Black, White, Green, Brown, Blue and Orange. **Autoclavable.**

Material: Vinyl
107 x 0.6 cm (each roll)

No. 29080-00
28,50 €

**MOST
POPULAR**



Instrument Tip Protectors

These tip protectors are a convenient, color-coded way to protect surgical instrument tips and edges. They provide exceptional protection and are vented to prevent rusting from condensation. Instrument tip protectors are recommended during handling, storage, and sterilization. **Autoclavable.**
Material: Plastisol



1.6 x 19.1 mm

Pkg. of 25
No. 29060-01
12,50 €



2 x 19 mm

Pkg. of 25
No. 29060-02
12,50 €



2.8 x 19.1 mm

Pkg. of 25
No. 29060-03
12,50 €



3.2 x 25.4 mm

Pkg. of 25
No. 29060-04
12,50 €



4.8 x 25.4 mm

Pkg. of 25
No. 29060-05
12,50 €



2 x 9.5 x 25.4 mm

Pkg. of 25
No. 29060-06
12,50 €



Assorted pack, five of each size

Pkg. of 30
No. 29060-00
14,50 €

**MOST
POPULAR**

Double Tip Protectors

These vented tip protectors are designed to hold hemostats and rongeurs firmly while allowing the jaws, box hinge and tips to stay open for thorough sterilization. **Autoclavable.**
Material: Plastisol



12.7 x 20 mm

Pkg. of 10
No. 29066-01
9,50 €



9 x 25.5 mm

Pkg. of 10
No. 29066-02
9,50 €



15 x 25 mm

Pkg. of 10
No. 29066-03
9,50 €



25 x 26 mm

Pkg. of 10
No. 29066-04
9,50 €



Assorted pack, three of each size

Pkg. of 12
No. 29066-00
11,00 €

**NEW
ITEM**

Self Sealing Sterilization Pouches

Preformed pouches with self adhering tape are blue tinted on one side for visualization of contents, and paper-backed on the other side. Pouches will work with either steam autoclave or ethylene oxide sterilization.

Advantages:

- Protects instruments during sterilization.
- Provides sterile storage until use.
- Write on pouches for easier identification during sterilization.



10 x 18 cm
For instruments up to 13 cm long

Pkg. of 100 pouches
No. 28000-07
28,50 €

13 x 26 cm
For instruments up to 23 cm long

Pkg. of 100 pouches
No. 28000-10
36,00 €

18 x 30 cm
For instruments up to 26 cm long

Pkg. of 100 pouches
No. 28000-12
47,50 €

Hot Bead Sterilizer

The sterilizer provides a safe, effective and convenient method for sterilizing your surgical instruments prior to and during surgery or tissue culture. Without using potentially dangerous gases, flames or chemicals, you can ensure that your instruments will be free of pathogens and microbial contaminants.

The beads take 15–20 minutes to reach 240°C to 270°C (464°F to 518°F), and then the sterilizer is ready for use. The temperature is thermostatically maintained, and the unit can be left on all day. Instruments require approximately 20 seconds of contact with the beads for complete sterilization. The sterilizer is safe to use even in laminar flow hoods.

Sterilization test results conducted by the Pasteur Institute in Lille, France, are available upon request. Available in 110V and 220V. CE Certified and UL Approved.

Sterilizer includes:

- Sterilizer unit
- 2 Bags of glass beads
- 1 Dust cover for well
- 1 Small heat-tempered glass dish for small objects (only with FST 250)



FST 250 shown.
Instruments not included.

STERILIZER

**MOST
POPULAR**

FST 250 Sterilizer

Well diameter: 4 cm
Well depth: 8 cm
Well volume: 100 ml
Total unit size: 14.5 x 12.5 x 13.5 cm

No. 18000-45
443,50 €

Replacement glass beads for FST 250

No. 18000-46
17,50 €

FST 350 Sterilizer

Well diameter: 4 cm
Well depth: 14 cm
Well volume: 175 ml
Total unit size: 20.5 x 12.5 x 13.5 cm

No. 18000-50
556,50 €

Replacement glass beads for FST 350

No. 18000-51
34,00 €

Autoclave Tape Dispenser

Easy loading core with heavy duty steel construction and a non-skid base. Serrated cutting blade cuts tape fast and cleanly.



Coated steel
23.5 cm

Tape sold separately.

No. 28001-00
24,50 €

Autoclave Tape

Tape will permanently indicate diagonal stripes after exposure to steam autoclave temperature between 121°C and 130° C during a 40-60 minute time period. Use with sterilization pouches, sterilization wraps and sterilization cases.

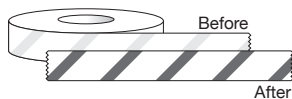

2 cm x 55 m

No. 28001-02
7,50 €

Surgical Skin Marker

This marker features a versatile tip for precise fine (0.2 mm) line marking, or when held at an angle, a broad (2 mm) line marking.

The marker's violet ink is nontoxic, non-tattooing and surgical prep-resistant. Markings can be removed from the skin with isopropyl alcohol. A six inch ruler calibrated in both centimeters and inches is included.



14 cm

No. 18000-30
4,00 €

Silicone Mat

High quality, extra soft mat for safe and secure placement of delicate instruments. This mat can easily be cut along the premarked grooves to fit in various sized instrument cases. **Autoclavable.**

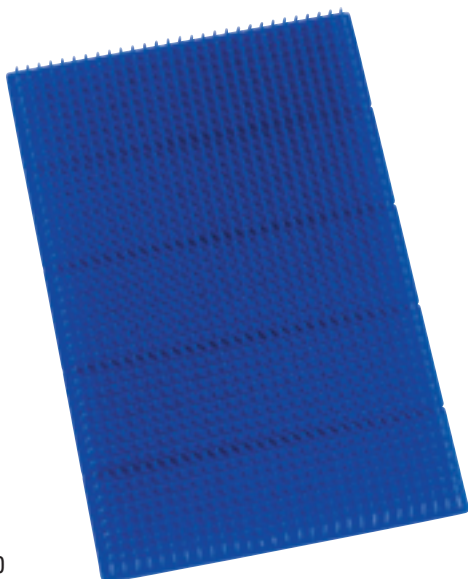

30 x 20 cm

No. 20325-00
104,50 €

Magnetic Sterilization Mat

Used during sterilization and for safe anti-slip placement around surgical settings. **Autoclavable.**



Instruments not included.

30 x 20 cm

No. 20350-00
117,50 €

Silicone Mat

Large, economical silicone mat.
Autoclavable.

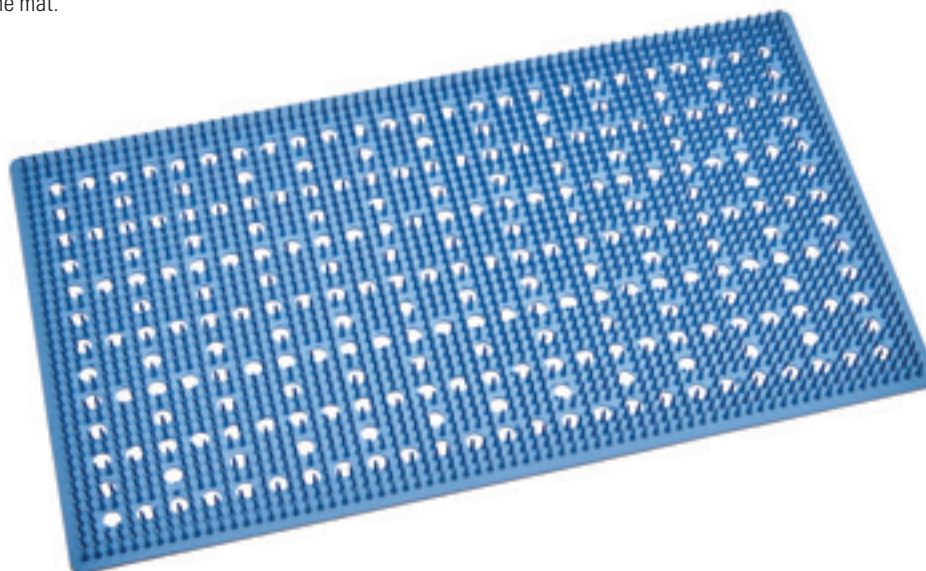

**NEW
ITEM**

46 x 25 cm

No. 20325-10
79,00 €

Sterilization Container

This plastic sterilization container includes a silicone mat for safe placement of instruments. Perforated top is clear for visual identification of instruments. **Suitable for autoclave or ethylene oxide sterilization.**

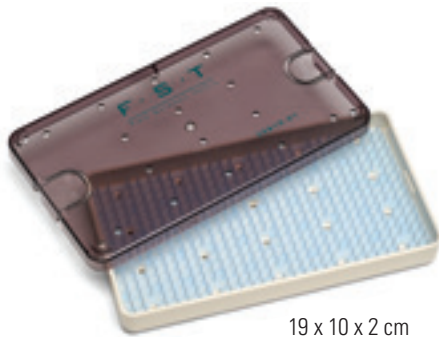

19 x 10 x 2 cm

**MOST
POPULAR**

No. 20810-01
118,00 €

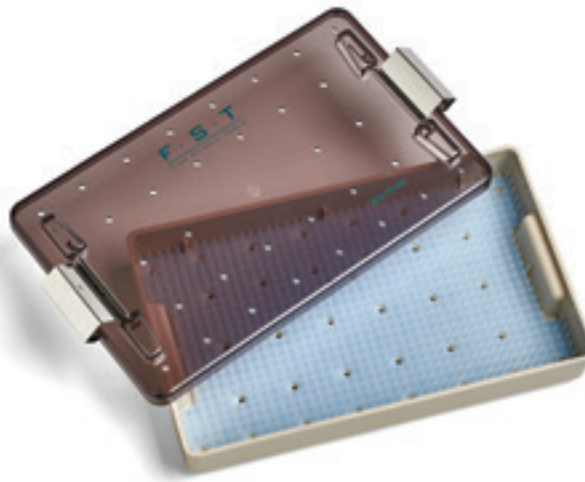

27 x 16 x 4 cm

No. 20810-02
179,00 €



Two Tiered Sterilization Container

This plastic sterilization container has two tiers of silicone slots that will accommodate up to 12 different instruments. Hinged top and bottom lock tight. Container is perforated. **Suitable for autoclave or ethylene oxide sterilization.**

25 x 12 x 3 cm

No. 20820-00
149,50 €

Disposable Sterilization Wraps

These biodegradable cellulose fiber wraps are resistant to tears and conform easily to maintain a breathable yet impervious barrier to airborne bacteria, saline, blood and water. Wrapping your instrument case securely will ensure the sterility of your instruments until ready for use. Available in two sizes.



38 x 38 cm

Pkg. of 25 wraps
No. 28015-15
5,50 €

51 x 51 cm

Pkg. of 25 wraps
No. 28020-20
8,50 €

Cases not included.

Sterilization Container

This sterilization container is made from Ultem® polymer to ensure strength and long lasting durability. The transparent perforated lid provides easy identification of your surgical instruments. Silicone mat is included for a safe and secure hold. Trays are also stackable for convenience.

Suitable for autoclave or ethylene oxide sterilization.

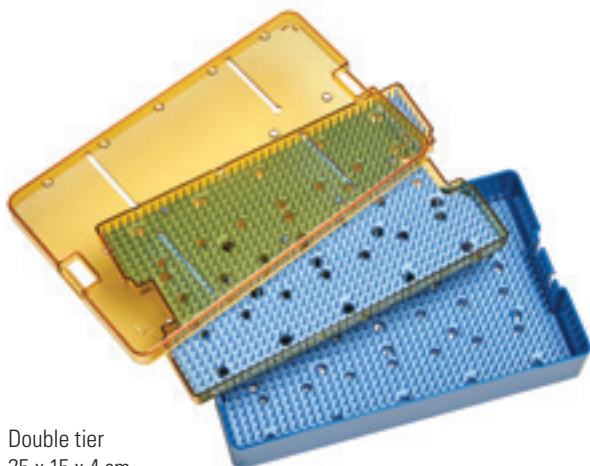

Double tier
25 x 15 x 4 cm

No. 20842-03
131,00 €

**NEW
ITEM**

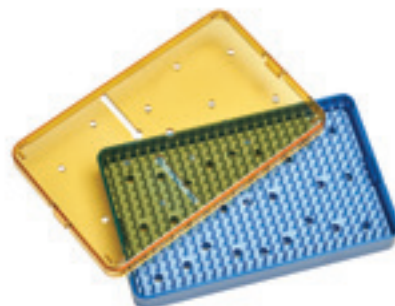

Single tier
17 x 10 x 2 cm

No. 20840-02
32,00 €

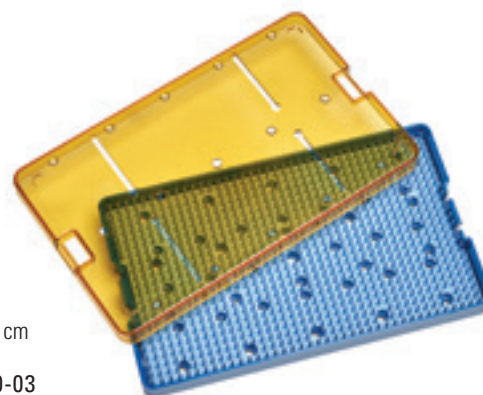

Single tier
25 x 15 x 2 cm

No. 20840-03
69,00 €

Dual Clasp Stainless Steel Sterilization Container

This container will assist in the sterilization and storage of your fine surgical instruments. It comes with a custom fit silicon mat and one single-use filter for keeping the instruments sterile while they remain in the container. **Suitable for autoclave or ethylene oxide sterilization.**



30 x 14 x 4 cm

No. 20850-00
195,00 €

5 Long-term textile filters
No. 20850-10
34,00 €

Stainless Steel Sterilization Container

Removable perforated interior plates hold long-term textile filters which keep the instruments sterile while they remain in the container. Lid can be locked in place. Comes with two textile filters installed. **Suitable for autoclave or ethylene oxide sterilization.**



20 x 10 x 4 cm

No. 20890-51
223,00 €

10 Long-term textile filters
No. 20890-72
58,00 €

Deluxe Stainless Steel Instrument Case

This case is built to withstand the roughest lab use. The lid is hinged and has a secure locking clasp. The inside bottom of the case is lined with a silicone mat which will cushion the most delicate instruments against impact.

The inside top of the lid has two specially shaped silicone strips which press down gently on the instruments inside the case as the lid is closed, holding them securely in place.

Case and silicone inserts are autoclavable but should not be used for sterilizing surgical instruments.

20 x 14 x 5 cm

No. 20020-00
279,00 €



Utility Instrument Case

Comes with a silicone mat for safe placement of instruments. **Case and silicone insert are autoclavable but should not be used for sterilizing surgical instruments.**

18 x 9 x 3 cm

No. 20311-21
74,50 €

**MOST
POPULAR**

Moria



Instrument Case

This plastic case is compact, safe, secure, and slotted for placement of individual surgical instruments, aiding in the prevention of tip damage. Five colors available.

Case is autoclavable but should not be used for sterilizing surgical instruments.

17 x 8 x 2 cm



Instruments not included.



Blue

No. 20830-00
15,00 €



Green

No. 20830-01
15,00 €

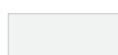

Clear

No. 20830-02
15,00 €



Yellow

No. 20830-03
15,00 €



Pink

No. 20830-04
15,00 €



Orange

No. 20830-05
15,00 €

Low Cost Cautery Kit

This low cost, high temperature cauterizer is a great alternative to disposable cautery units. Temperature at tips is approximately 1000°C (1832°F). Replacement cautery tips are available. **Not autoclavable.**



Plastic body
Stainless steel tips: 0.2 mm diameter
Total weight: 60 g
Length: 17.5 cm (without tip)

- Cautery kit includes:
- 1 Cautery handle
 - 2 AA Batteries
 - 2 Standard tips
 - 1 Storage case
 - 2 Fine tips

Cautery kit
No. 18010-00
71,00 €

MOST POPULAR

65% of actual size



Replacement tips
Straight standard

Box of 10 tips
No. 18010-01
68,00 €



Replacement tips
Straight fine

Box of 10 tips
No. 18010-02
73,50 €

Small Vessel Cauterizer

This small hand-held unit keeps bleeding to a minimum and therefore provides a surgical field clear of clamps and hemostats. The cauterizer should be activated momentarily so the delicate tips do not burn out. Temperature at tips is approximately 1000°C (1832 °F). Replacement cautery tips are available. **Autoclavable.**



Heavy gauge stainless steel body
Platinum-iridium tips: 0.3 mm diameter
Total weight: 100 g
Length: 13.5 cm (without tip)

- Cautery kit includes:
- 1 Cautery handle
 - 2 AA Batteries
 - 1 Straight fine tip
 - 1 Storage Case
 - 1 Angled fine tip

Cautery kit
No. 18000-00
316,50 €

Cautionary note:

Remove batteries before autoclaving.

65% of actual size



Replacement tip
Straight fine

No. 18000-01
50,00 €



Replacement tip
Angled fine

No. 18000-02
50,50 €



Replacement tip
Straight knife

No. 18000-03
50,00 €



Replacement tip
Straight knob

No. 18000-04
50,00 €

Neuro Punches

N.I.H. style neuro punches for punch removal of frozen brain microregions.

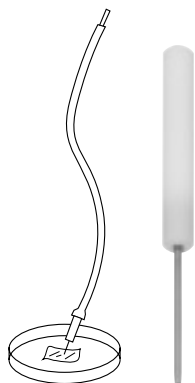

| ID (mm) | OD (mm) | Gauge | Length (cm) | Item | Price |
|---------|---------|-------|-------------|--------------|---------|
| 0.31 | 0.61 | 24 | 4.2 | No. 18036-24 | 37,50 € |
| 0.41 | 0.70 | 22 | 4.5 | No. 18036-22 | 41,50 € |
| 0.69 | 1.00 | 19 | 4.5 | No. 18036-19 | 33,50 € |

Sample Corers

For quantitative analysis. Comes with plunger.

8.5 cm



| ID (mm) | OD (mm) | Gauge | Item | Price |
|---------|---------|-------|--------------|---------|
| 0.35 | 0.80 | 21 | No. 18035-35 | 64,50 € |
| 0.50 | 1.00 | 19 | No. 18035-50 | 60,50 € |
| 0.80 | 1.45 | 17 | No. 18035-80 | 62,00 € |
| 1.00 | 1.80 | 15 | No. 18035-01 | 51,50 € |
| 2.00 | 3.00 | 11 | No. 18035-02 | 51,50 € |
| 3.00 | 4.00 | 8 | No. 18035-03 | 54,00 € |
| 5.00 | 6.00 | 4 | No. 18035-05 | 56,50 € |

Absorption Spears and Triangles

These synthetic surgical sponges absorb fluids twice as fast as the best cotton sponges and have three times their fluid-holding capacity. They are made from strong, soft, lint-free biocompatible-proven material that is non-irritating to delicate tissue and leaves no fibrous residue that might cause wound contamination. The Absorption Spears are sterilized by radiation.



Absorption Spears Sterile

7 cm

Box of 200 spears
No. 18105-01
106,00 €

Absorption Triangles Sterile

2 cm

Box of 500 triangles
No. 18105-03
96,00 €

Instrument Beaker with Silicone Bottom

Instruments are placed in the beaker with their tips immersed in distilled water when not in immediate use. This keeps the instruments clean and functional and ready to grasp. The instrument tips are protected from damage by the soft silicone rubber bottom. Segmented lid keeps instruments organized and secure.

Diameter: 10 cm
Height: 8 cm

No. 00081-00
169,00 €

S&T®



Instrument not included.

Instrument Holding Spring

For the safe placement of delicate surgical instruments during use. Pin the sharp ends into the drape to secure the mounting spring.

Diameter: 2 cm
Length: 4 cm (closed)

No. 18090-00
15,00 €

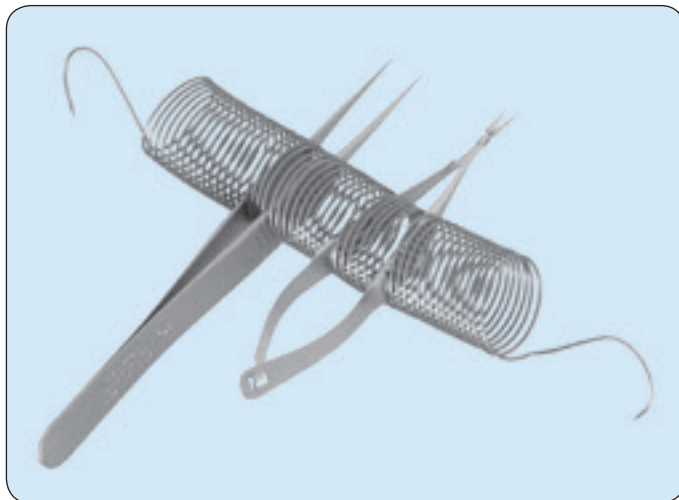

Instruments not included.

Stainless Steel Burrs

Shaft diameter: 2.3 mm
Length: 44 mm
Pkg. of 10 burrs



| Diameter (mm) | Item | Price |
|---------------|--------------|---------|
| 0.7* | No. 19008-07 | 20,00 € |
| 0.9** | No. 19008-09 | 20,00 € |
| 1.4 | No. 19008-14 | 20,00 € |

* Use this size for screws No. 19010-10.

** Use this size for screws No. 19010-00.

Carbon Steel Burrs

Shaft diameter: 2.3 mm
Length: 44 mm
Pkg. of 10 burrs



| Diameter (mm) | Item | Price |
|---------------|--------------|---------|
| 0.5 | No. 19007-05 | 13,50 € |
| 0.7* | No. 19007-07 | 13,50 € |
| 0.9** | No. 19007-09 | 14,50 € |
| 1.4 | No. 19007-14 | 15,50 € |
| 2.1 | No. 19007-21 | 16,50 € |
| 2.9 | No. 19007-29 | 21,00 € |

* Use this size for screws No. 19010-10.

** Use this size for screws No. 19010-00.

**MOST
POPULAR**

Stainless Steel Trephines

Side opening for clearing of material.

Shaft diameter: 2.3 mm
Length: 44 mm
Sold individually

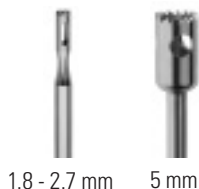

1.8 - 2.7 mm 5 mm

| Diameter (mm) | Item | Price |
|---------------|--------------|---------|
| 1.8 | No. 18004-18 | 14,50 € |
| 2.3 | No. 18004-23 | 15,00 € |
| 2.7 | No. 18004-27 | 15,50 € |
| 5 | No. 18004-50 | 25,00 € |

DRILL BITS

Stainless Steel Circular Saw

For cutting bone and other hard substances.
Attaches to mandrel (No. 18000-18), right.

Diameter: 16 mm
Thickness: 0.1 mm

Pkg. of 10 saws
No. 18000-20
26,00 €

**Stainless Steel Mandrel**

Screw allows attachment of discs and circular saws for use with high speed drills.

Shaft diameter: 2.3 mm
Length: 45 mm

No. 18000-18
5,00 €



Miniature File Set

Comes with 8 different file profiles in a vinyl pouch.
Not autoclavable.



10 cm

No. 30076-14
95,00 €

Screwdriver Set

6 screwdrivers with nickel-plated handles, hardened blades of 1, 1.5, 1.8, 2.3, 2.9 and 3.6 mm width. Comes in a wooden case.



No. 30090-06
47,00 €

4-in-1 Screwdriver

With 4 hardened, interchangeable blades stored in handle.

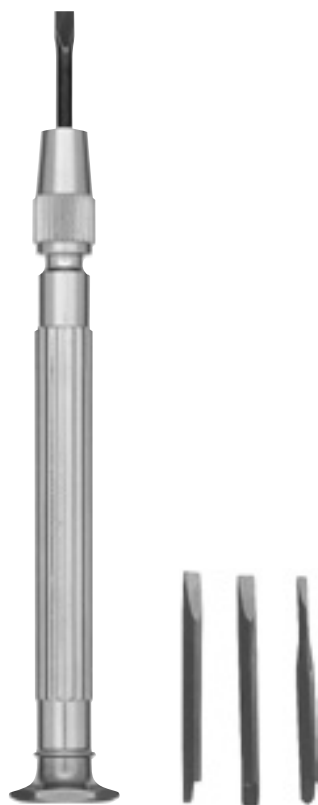

10.5 cm

No. 30051-10
16,50 €

Utility Scissors

These scissors are extremely hard (54 on the Rockwell scale). Useful for cutting tin or aluminum sheets, bone, plastics, etc. The strong, 3 mm thick blades are magnetic. The plastic handles are anatomically shaped. **Not autoclavable.**



75% of actual size

Stainless steel with plastic handle
21 cm

Right-handed
No. 37500-00
22,50 €

**LEFT
HANDED** 
No. 37000-00
30,50 €

Ruler with Gauge Measurements



Front

Back

Stainless steel

15 cm (6")
No. 30085-15
8,00 €

Ruler with Metric Conversion Table

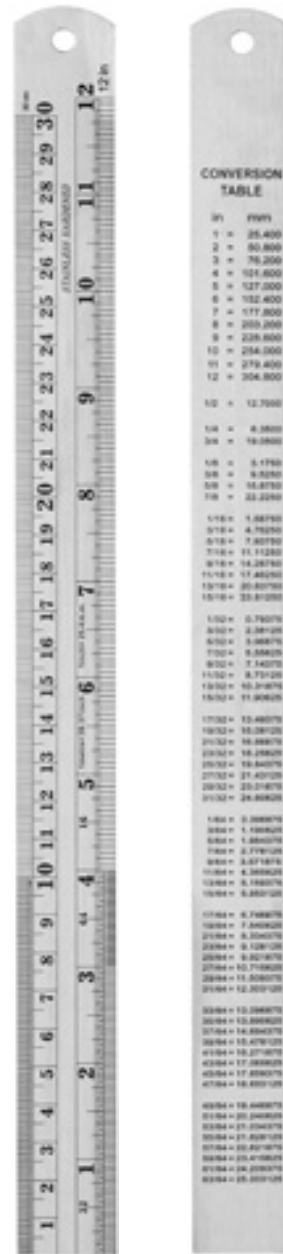

Front

Back

55% of actual size

Stainless steel

30 cm (12")
No. 30085-30
10,00 €

CONVERSION TABLE

| in | mm |
|--------|---------|
| 1 | 25.400 |
| 2 | 50.800 |
| 3 | 76.200 |
| 4 | 101.600 |
| 5 | 127.000 |
| 6 | 152.400 |
| 7 | 177.800 |
| 8 | 203.200 |
| 9 | 228.600 |
| 10 | 254.000 |
| 11 | 279.400 |
| 12 | 304.800 |
| 1/2 | 12.700 |
| 3/4 | 19.050 |
| 1 | 25.400 |
| 1 1/4 | 31.750 |
| 1 1/2 | 38.100 |
| 1 3/4 | 44.450 |
| 2 | 50.800 |
| 2 1/4 | 57.150 |
| 2 1/2 | 63.500 |
| 2 3/4 | 69.850 |
| 3 | 76.200 |
| 3 1/4 | 82.550 |
| 3 1/2 | 88.900 |
| 3 3/4 | 95.250 |
| 4 | 101.600 |
| 4 1/4 | 107.950 |
| 4 1/2 | 114.300 |
| 4 3/4 | 120.650 |
| 5 | 127.000 |
| 5 1/4 | 133.350 |
| 5 1/2 | 139.700 |
| 5 3/4 | 146.050 |
| 6 | 152.400 |
| 6 1/4 | 158.750 |
| 6 1/2 | 165.100 |
| 6 3/4 | 171.450 |
| 7 | 177.800 |
| 7 1/4 | 184.150 |
| 7 1/2 | 190.500 |
| 7 3/4 | 196.850 |
| 8 | 203.200 |
| 8 1/4 | 209.550 |
| 8 1/2 | 215.900 |
| 8 3/4 | 222.250 |
| 9 | 228.600 |
| 9 1/4 | 234.950 |
| 9 1/2 | 241.300 |
| 9 3/4 | 247.650 |
| 10 | 254.000 |
| 10 1/4 | 260.350 |
| 10 1/2 | 266.700 |
| 10 3/4 | 273.050 |
| 11 | 279.400 |
| 11 1/4 | 285.750 |
| 11 1/2 | 292.100 |
| 11 3/4 | 298.450 |
| 12 | 304.800 |
| 12 1/4 | 311.150 |
| 12 1/2 | 317.500 |
| 12 3/4 | 323.850 |
| 13 | 330.200 |
| 13 1/4 | 336.550 |
| 13 1/2 | 342.900 |
| 13 3/4 | 349.250 |
| 14 | 355.600 |
| 14 1/4 | 361.950 |
| 14 1/2 | 368.300 |
| 14 3/4 | 374.650 |
| 15 | 381.000 |
| 15 1/4 | 387.350 |
| 15 1/2 | 393.700 |
| 15 3/4 | 400.050 |
| 16 | 406.400 |
| 16 1/4 | 412.750 |
| 16 1/2 | 419.100 |
| 16 3/4 | 425.450 |
| 17 | 431.800 |
| 17 1/4 | 438.150 |
| 17 1/2 | 444.500 |
| 17 3/4 | 450.850 |
| 18 | 457.200 |
| 18 1/4 | 463.550 |
| 18 1/2 | 469.900 |
| 18 3/4 | 476.250 |
| 19 | 482.600 |
| 19 1/4 | 488.950 |
| 19 1/2 | 495.300 |
| 19 3/4 | 501.650 |
| 20 | 508.000 |
| 20 1/4 | 514.350 |
| 20 1/2 | 520.700 |
| 20 3/4 | 527.050 |
| 21 | 533.400 |
| 21 1/4 | 539.750 |
| 21 1/2 | 546.100 |
| 21 3/4 | 552.450 |
| 22 | 558.800 |
| 22 1/4 | 565.150 |
| 22 1/2 | 571.500 |
| 22 3/4 | 577.850 |
| 23 | 584.200 |
| 23 1/4 | 590.550 |
| 23 1/2 | 596.900 |
| 23 3/4 | 603.250 |
| 24 | 609.600 |
| 24 1/4 | 615.950 |
| 24 1/2 | 622.300 |
| 24 3/4 | 628.650 |
| 25 | 635.000 |
| 25 1/4 | 641.350 |
| 25 1/2 | 647.700 |
| 25 3/4 | 654.050 |
| 26 | 660.400 |
| 26 1/4 | 666.750 |
| 26 1/2 | 673.100 |
| 26 3/4 | 679.450 |
| 27 | 685.800 |
| 27 1/4 | 692.150 |
| 27 1/2 | 698.500 |
| 27 3/4 | 704.850 |
| 28 | 711.200 |
| 28 1/4 | 717.550 |
| 28 1/2 | 723.900 |
| 28 3/4 | 730.250 |
| 29 | 736.600 |
| 29 1/4 | 742.950 |
| 29 1/2 | 749.300 |
| 29 3/4 | 755.650 |
| 30 | 762.000 |

Plastic Vernier Caliper

Tough polymer is unbreakable under normal conditions. Measures inside, outside, step and depth, metric and inch to 0.1 mm or 1/64". Capacity is 13 cm.



75% of actual size

21 cm

No. 30087-20
19,50 €

Digital Electronic Caliper

Wide screen LED display with the ability to measure in millimeters, inches and fractions. Measures inside, outside, step and depth. Battery, spare battery and plastic storage case included.



70% of actual size

Stainless steel
23.5 cm

No. 30087-00
33,00 €

Castroviejo Surgical Caliper

Used for precise measurement during surgery.



0-20 mm with 0.5 mm divisions
Tip diameter: 0.5 mm
8.5 cm

No. 18000-35
250,50 €



Large Scale Stage Micrometer

A precision glass scale suitable for calibration and measurement of large field stereo microscope images. Comes with 15x eyepiece and case.

50 mm with 500 divisions (0.1 mm)
80 x 25 mm
8 cm

No. 29026-00
185,50 €



Stage Micrometers

These are highly accurate stage micrometers for use with transmitted light in both compound and stereo microscopes. Comes with a plastic case.

76 x 26 mm

10 mm with 100 divisions (0.1 mm)
No. 29025-01
137,50 €

1 mm with 100 divisions (0.01 mm)
No. 29025-02
144,00 €



Ruler Label

Used for stable measurements in all surgical platforms.

6 cm

Pkg. of 25 labels
No. 29027-00
4,00 €

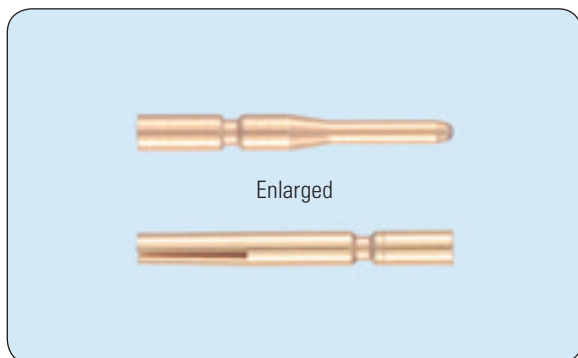

Gold Wire Contacts

Matching pin and socket. Contacts are crimp terminated, but also can be used for solder connections.

Total length: 16 mm (when connected together)

Diameter: 1.2 mm

Opening for wire: 0.63 mm

Pkg. of 50 male contacts

No. 19003-00

52,00 €

Pkg. of 50 female contacts

No. 19003-01

74,00 €

Electronic Stopwatch / Timer

Stopwatch: Counts up to 60 minutes then recycles automatically. Timer: Counts down from 100 minutes or any lesser preset time in minutes and seconds.

Not available in Europe.

LCD display: 2 x 5 cm
6.5 x 6.5 x 1.5 cm
AAA battery included

No. 27000-10

Electronic Clock / Triple Timer

Three activities can be timed up or down simultaneously or individually. Time can be displayed either in 12 or 24 hours and features a memory function. Maximum countdown time is 19 hours, 59 minutes, 59 seconds. Minimum time interval is 1 second. The timer housing includes a powerful magnet for mounting.



LCD display: 4.5 x 4.5 cm
7 x 8.5 x 1.5 cm
AAA battery included

**NEW
ITEM**

No. 27000-01
23,00 €

Eschenbach Labo-Clip

Lightweight, comfortable, and fully adjustable. Clip attaches directly to your eyeglasses and works with three interchangeable lenses shown below.



Interchangeable Lenses



Magnification: 3x
74 mm x 28 mm

No. 28090-30
35,50 €



Magnification: 4x
37.5 mm diameter

No. 28090-40
26,50 €



Magnification: 7x
37.5 mm diameter

No. 28090-70
28,50 €

| Item | Working distance | Lens type | Diopter | Lens material |
|--------------|------------------|-----------|---------|---|
| No. 28090-30 | 160 mm | Binocular | 7.75D | PXM® lightweight lens with Ceratec® scratch-resistant coating |
| No. 28090-40 | 55 mm | Monocular | 16D | PXM® lightweight lens with Ceratec® scratch-resistant coating |
| No. 28090-70 | 32 mm | Monocular | 28D | PXM® lightweight lens with Ceratec® scratch-resistant coating |



Headband magnifier shown with VisorLIGHT™ (sold separately).



Headband Magnifier

Precision ground and polished optical glass lenses. The padded headband is lightweight and fully adjustable. Can be worn with spectacles.

Magnification: 2.5x
Working distance: 200 mm (8")

No. 28030-02
63,00 €

Magnification: 2.75x
Working distance: 150 mm (6")

No. 28030-03
63,00 €



Magnification: 3.5x
Working distance: 100 mm (4")

No. 28030-04
65,00 €

VisorLIGHT™

Small, portable light source with 3.9 cm cord for attachment to headband. It comes with a battery pack that holds two AA batteries. Completely adjustable. Replacement bulbs are available upon request.

No. 28030-10
35,00 €

Interchangeable Magnifier Headset with LED

Economical and fully interchangeable headband magnifier with LED light.

Includes:

- Glasses Frame with Adjustable Lens Holder
- Adjustable Head Strap
- Magnification Lenses (1x, 1.5x, 2x, 2.5x, and 3.5x) with a protective storage box
- 2 Super Bright White LED bulbs
- 3 AG10 Batteries

Magnification: 1x, 1.5x, 2x, 2.5x, and 3.5x
Field of view: Variable
Working distance: Variable

No. 28080-00
44,00 €



Can be used with or without the adjustable head strap (included).



Eschenbach Max Detail Spectacles

These spectacles are portable, lightweight, and easily adjustable. Designed with frosted objective lens housing which eliminates distracting reflections. Bendable ear pieces for a secure, comfortable fit. Protective case is included.

Magnification: 2x
Field of view: 110 mm (4")
Working distance: 400 mm (16")
Weight: 49 g

No. 28030-20
89,50 €

**MOST
POPULAR**



Max Detail Spectacles shown with Eschenbach Clip-On LED Light (sold separately).

Eschenbach Clip-On LED Light

A compact and lightweight light source with two high-performance SMD LED's and a lens that concentrates the light producing a more powerful, bright and homogenous field of view. Light can be set high or low. Compatible with the Max Detail Spectacles and Headband Magnifiers. Comes with 3 AA batteries and storage case.

Weight: 11 g
No. 28030-25
103,50 €



Eschenbach Magnifier Spectacles

These magnifier spectacles allow full adjustments on almost all parts. Headband keeps spectacles steady and in place. (Sold separately.) Leather case included.

Magnification: 2.5x
Working distance: 350 mm (14")
Weight: 70 g
Plastic frame reinforced with fiberglass

No. 28040-30
284,00 €



Spectacles Headband

Compatible with the Eschenbach Max Detail Spectacles (Item No. 28030-20) and Eschenbach Magnifier Spectacles (Item No. 28040-30).

Material: Neoprene

No. 28080-90
7,50 €



Galilean Loupes

These loupes are lightweight and easy to use. Made from the finest optical coated lenses which deliver excellent clarity and high resolution. The loupes are mounted onto a strong yet flexible wraparound safety frame with a headband for stability and comfort. Ability to flip loupes up for use as safety glasses. Comes with mini screwdriver for fine adjustments, micro cloth, and storage case.



Magnification: 3x
Working distance: 400 mm (16")
Weight: 72 g

No. 28050-30
189,00 €

Magnification: 3.5x
Working distance: 300 mm (12")
Weight: 77 g

No. 28050-35
199,00 €



Optical Cleaning Kit

This convenient kit contains everything you need to clean lens surfaces safely. Perfect for microscopes, camera lenses, binoculars, telescopes, graphic art optics, and all other fragile lenses. Storage case included.

Kit includes:

- 1 Bottle of lens cleaner (30 ml)
- 1 Ultra soft duster brush
- 1 Cleaning cloth (20 x 20 cm)
- 3 Books of lens paper (25 sheets each)

No. 29000-10
33,50 €



Lens Paper

This premium grade optical lens tissue is extremely soft and safe for any glass or plastic optical lens surface.

15 x 10 cm

Book of 50 sheets
No. 29015-50
5,50 €

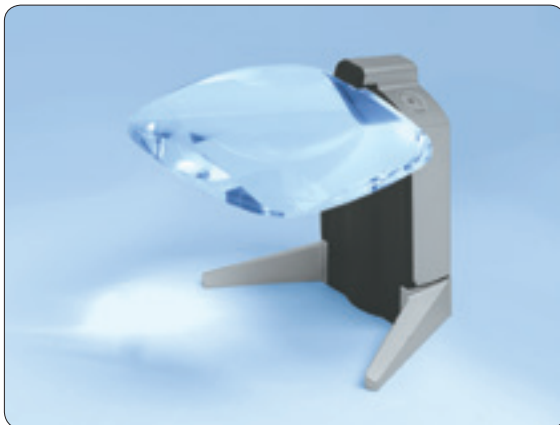

Eschenbach Scribolux Magnifier

This magnifier provides an illuminated platform suitable for any working condition. The open design allows for a spacious working platform. Supplied in a microfiber pouch for protecting and cleaning the lens.

Magnification: 2.8x
Diopter: 7/11D
Lens size: 100 x 75 mm
Lens shape: Aspheric
Working distance: 75 mm (3")
Lens material: PXM® lightweight lens with patented Ceratec® scratch-resistant coating
Illumination: Latest SMD LED technology
Power source: 4 AA batteries (included)

No. 28020-28
101,50 €

Flex Magnifier with LED

This desktop gooseneck LED lighted magnifier is a hands-free, flexible, and lightweight alternative to a dissecting scope. This magnifier is cost efficient and can be used with an AC wall adaptor or wireless with batteries. AC wall adaptor sold separately.

Magnification: 2x/6x Mini Bifocal
 Diopter: 2.9D
 Lens size: 102 mm
 Lens shape: Biaspheric
 Working distance: Variable
 Lens material: PMMA Acrylic
 Illumination: Super Bright LED
 Power source: 3 AA batteries (included)
 or by AC Unit (Item No. 28011-00 or 28011-01)

| | | |
|---------------------|---------------------|---------------------|
| Magnifier | 120V Wall Adapter | 220V Wall Adapter |
| No. 28011-20 | No. 28011-00 | No. 28011-01 |
| 35,50 € | 9,00 € | 13,00 € |



Eschenbach Vario Flex with LED

The Vario LED Flex ensures ease and precision by its smooth flexible neck and tiltable magnifying lens. This magnifier's innovative features provide a spacious working platform suitable for any application. Mounting clamp provides uncompromised workspace due to its sturdy, slim design. The magnification lens is illuminated with shadow-free full or half ring optimum bright LEDs.

Magnification: 2.5x
 Diopter: 6D
 Lens size: 76 mm
 Lens shape: Aspheric
 Working distance: Variable
 Lens material: PXM® lightweight lens with patented Ceratec® scratch-resistant coating
 Illumination: Latest SMD LED technology
 Power source: 120V & 220V

No. 28015-25
 449,50 €





Student Quality Instruments

| | | |
|--|-------|-----------|
| Scissors | Pages | 173 – 174 |
| Vessel Dilator | Page | 175 |
| Forceps | Pages | 175 – 177 |
| Hemostat, Needle Holder, Pin Holder, Scalpel Handle & Retractor | Pages | 178 – 179 |



Vannas Spring Scissors

Ideal for introductory courses in microdissection. The manufacturer, material and general pattern are the same as our No. 15003-08 but with much of the costly hand finishing omitted.



Cutting edge: 5 mm
Tip diameter: 0.35 mm
9 cm



Straight

No. 91500-09
56,50 €



Curved

No. 91501-09
62,50 €

**MOST
POPULAR**

Fine Scissors

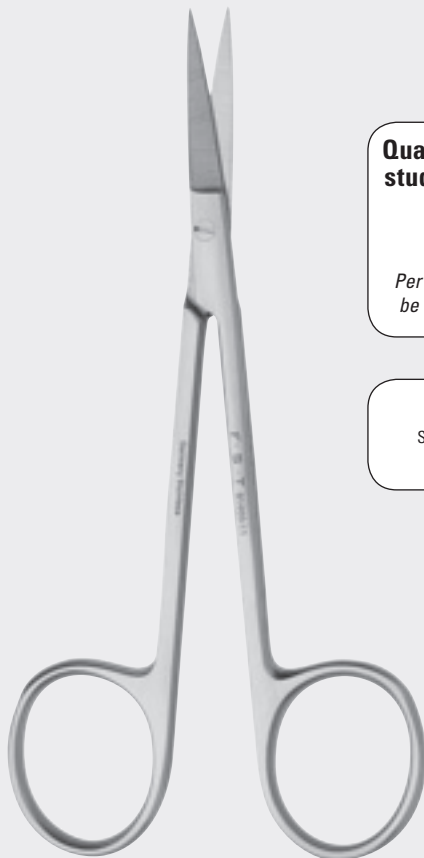

11.5 cm



Straight

No. 91460-11
25,00 €



Curved

No. 91461-11
30,50 €

**MOST
POPULAR**

Quantity discount for student instruments:

5-9 = 5%

10+ = 10%

Per item, selection cannot be assorted for discount.

For more info on student instruments see page 187.

Surgical Scissors

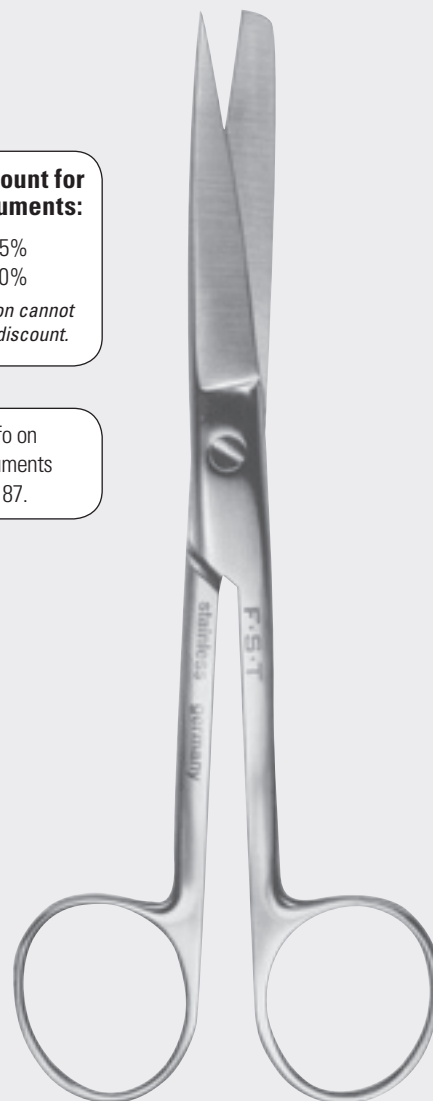

Sharp/Sharp

12 cm
No. 91402-12
21,00 €

14.5 cm
No. 91402-14
22,50 €



Sharp/Blunt

12 cm
No. 91401-12
20,00 €

14.5 cm
No. 91401-14
21,00 €



Blunt/Blunt

12 cm
No. 91400-12
18,00 €

14.5 cm
No. 91400-14
19,50 €

Lister Scissors

Longer blunt blade prevents damaging tissue underneath skin without losing the cutting line.



Angled to side
Blunt/Blunt
14 cm

No. 91413-14
24,50 €

Bone Scissors

For cutting fine bone.



Curved
Cutting edge: 9 mm
9 cm

No. 91604-09
32,00 €

Quantity discount for student instruments:

5-9 = 5%
10+ = 10%

Per item, selection cannot be assorted for discount.

For more info on student instruments see page 187.

Vessel Dilator



Angled 10°
Tip diameter: 0.5 mm
11 cm

No. 91815-11
86,50 €

Standard Pattern

Broad pattern with strong spring action.



Serrated

Tip width: 2.5 mm
11.5 cm
No. 91100-12
11,00 €

Tip width: 3.5 mm
16 cm
No. 91100-16
10,50 €

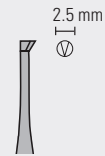

1x2 teeth

Tip width: 2.5 mm
12 cm
No. 91121-12
11,00 €

Quantity discount for student instruments:

5-9 = 5%
10+ = 10%

Per item, selection cannot be assorted for discount.

Adson

Wide, strong grip with narrow tips.



Tip width: 1.5 mm
12 cm



Serrated

No. 91106-12
14,00 €

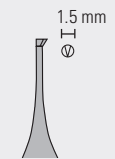

1x2 teeth

No. 91127-12
17,00 €

Dumont #5

Dumont #7

Quantity discount for student instruments:

5-9 = 5%

10+ = 10%

Per item, selection cannot be assorted for discount.

For more info on student instruments see page 187.



MOST POPULAR

Standard tip
0.1 x 0.06 mm
Inox
11 cm

No. 91150-20
27,50 €

Standard tip
0.17 x 0.1 mm
Inox
11 cm

No. 91197-00
28,50 €

STUDENT

Fine Forceps Straight



0.2 x 0.1 mm
11 cm

No. 91115-10
26,50 €

Fine Forceps Broad Shanks



0.2 x 0.2 mm
11 cm

No. 91113-10
27,00 €

Fine Forceps Curved



0.2 x 0.2 mm
11 cm

No. 91117-10
29,50 €

Fine Forceps Angled



0.2 x 0.2 mm
11 cm

No. 91110-10
29,00 €

Quantity discount for student instruments:

5-9 = 5%

10+ = 10%

*Per item, selection cannot
be assorted for discount.*

Halsted-Mosquito Hemostat

Halsey Needle Holder

Quantity discount for student instruments:

5-9 = 5%
10+ = 10%

Per item, selection cannot be assorted for discount.

For more info on student instruments see page 187.



Straight
12.5 cm

No. 91308-12
18,00 €



Curved
12.5 cm

No. 91309-12
20,50 €



13 cm

No. 91201-13
31,00 €

For suture needles, see page 116 & 117.

STUDENT

Pin Holder

Nickel-plated
Jaw opening: 0-1 mm
7.5 cm

No. 91606-07
10,00 €

For pins, see
page 107.

**Standard Scalpel
Handle #3**

12 cm

No. 91003-12
10,00 €

For scalpel blades,
see page 58.

**Quantity discount for
student instruments:**

5-9 = 5%

10+ = 10%

*Per item, selection cannot
be assorted for discount.*

Spring-Loaded Retractor

Curved atraumatic blades
Maximum spread: 3 cm
Blade dimensions: 14 x 10 mm
8.5 cm

No. 91706-05
27,50 €



Reference Pages

| | | |
|------------------------|-------|-----------|
| Worldwide Locations | Page | 181 |
| Scissors Test | Page | 182 |
| Features and Alloys | Page | 183 |
| Maintenance and Care | Pages | 184 – 185 |
| Quality Control | Page | 186 |
| Student Line | Page | 187 |
| Selection | Page | 188 |
| Dumont | Page | 189 |
| Numerical Index | Pages | 190 – 193 |
| Alphabetical Index | Pages | 194 – 199 |
| Additional Information | Page | 200 |



Fine Science Tools Around the World

Commitment to excellence

For decades, we've demonstrated our commitment to excellence with genuine quality and a 100% satisfaction guarantee. As a result, our products continue to be the preferred instruments among scientists and biomedical researchers worldwide.



We have offices and dealers throughout the world
and have been shipping globally since 1974.



Offices

finescience.com
finescience.de
finescience.ca

USA
Europe
Canada/International



Dealers

To see a complete list of Fine Science Tools dealers,
please visit us at finescience.de/Dealers.

Does paying more for a pair of scissors really buy more value and a longer cutting life?

Pictured below is a scissors testing device used to compare various alloys and cutting edge styles. The scissors repeatedly cut through a continuous feed of cotton cloth, and a counter keeps track of the number of cuts made to evaluate when the scissors begin to show a decrease in cutting quality.

The results verify that the addition of various features dramatically increases the cutting life of the scissors. Most notably, the cutting life is more than doubled with the addition of ToughCut blades to stainless steel, and over six times longer with CeramaCut blades.

See the chart below for a comparison of four different scissors sold by FST.



The cutting life is more than doubled with the addition of ToughCut blades to stainless steel, and over six times longer with CeramaCut blades.

| Alloy/Material | Lasts longer than stainless steel by: |
|---|---------------------------------------|
| Tungsten Carbide | 1.9x |
| Stainless Steel with ToughCut | 2.3x |
| Tungsten Carbide with ToughCut | 4.1x |
| CeramaCut (Ceramic Coated Tungsten Carbide with ToughCut) | 6.6x |

See page 183 for more information on ToughCut, Tungsten Carbide and CeramaCut.

Tungsten Carbide

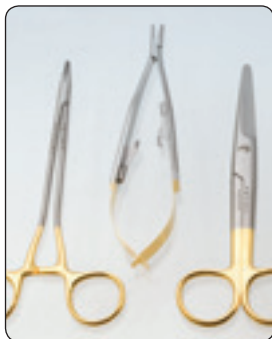

When you place heavy demands on your surgical instruments, be it scissors, needle holders, or forceps, you should consider the benefits of tungsten carbide, one of the hardest alloys available. Tungsten carbide scissors last almost two times longer than stainless steel, and needle holder tips can be made with a pyramid cross pattern that holds suture needles much more securely. Inlays are either glued or welded into place.

Compare the extra cost of these instruments with the length of useful wear and you have a cost effective solution for your instrument requirements. Tungsten carbide instruments are identified by their gold handles.

Scissors: pages 9, 20–21, 23, 30–32, 34 and 44

Forceps: page 84

Needle Holders: pages 111–115

Look for this symbol



ToughCut® Scissors



ToughCut scissors feature two unique cutting edges that cut through the toughest tissue with exceptional ease and accuracy. One blade is honed to razor sharpness, and the other is micro-serrated to minimize tissue slippage during cutting. Scissors with ToughCut edges are identified by their black handles.

For ToughCut scissors that last almost two times longer, select ToughCut with tungsten carbide cutting edges.

Scissors: pages 6, 15, 20–21, 25, 30, 33–34

Look for this symbol



Ceramic and CeramaCut® Instruments

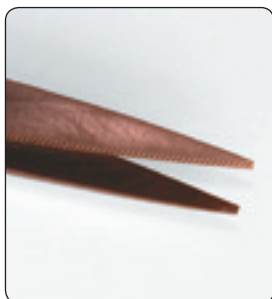

One of the hardest materials on Earth, ceramic is used in surgical instruments to form edges that last longer than stainless steel and even longer than tungsten carbide. Ceramic also has a high slide capacity which reduces surface tension and results in a much cleaner cut than metal instruments. Our CeramaCut scissors combine ToughCut technology with tungsten carbide edges and a ceramic coating for one of the best, cleanest cutting scissors available on the market today.

CeramaCut Scissors: page 21

Ceramic Blades: page 52

Ceramic Coated Forceps: pages 63 and 69

Ceramic Coated Spring Scissors: pages 7 and 10

Look for this symbol



Titanium

Titanium instruments are over 40% lighter than equivalent stainless steel instruments, with better flexibility and strength. Elemental titanium (Ti) is a very strong, lustrous, white metal with a specific gravity of 4.54. Titanium and titanium alloys readily form stable protective surface layers, giving them excellent corrosion resistance to saltwater, laboratory saline solutions, blood and other bodily fluids, oxidizing acids, alkalis and chlorides. Titanium is 100% nonmagnetic; a great benefit when working with nerves. Its inherent surface oxide film provides bactericidal and non-allergenic properties. Titanium alloys can be heated up to 440°C (824°F).

Scissors: pages 5 and 10

Forceps: pages 65, 69, 80, 86 and 90

Probes: page 102

Vascular Clamps: pages 132–133

Look for this symbol



Cleaning, Sterilization, Maintenance, & Storage of Surgical Instruments

Proper care of your surgical instruments will improve their longevity and function. Below are different cleaning, sterilization, and maintenance processes to guide you through your techniques.

General Care & Maintenance

Guidelines to extend the life of your surgical instruments.

- Clean and thoroughly dry your instruments as soon as possible after each use, paying special attention to joints, hinges, and anywhere there is metal to metal contact.
- Handle your instruments delicately and with care.
- Use your instruments for their intended purpose.
- Store your instruments with tip protectors, and always place them so that they do not touch each other.

Cleaning

Fine surgical instruments should be cleaned immediately after use. Blood or saline solutions left on instruments for any length of time can quickly start corrosive action. Time, temperature, and agitation play important roles in the cleaning process. Time affects the efficiency of cleaning solutions as most are effective after a certain time period. Higher temperature cleaning solutions result in better cleaning. During manual or ultrasonic cleaning it is helpful to loosen any surgical residue. Before any of the below procedures, rinse your instruments under warm running water to remove all blood and tissue. Instruments can be cleaned manually or ultrasonically, but always:

- Use a neutral pH (pH 7) cleaning solution.
 - Clean instruments in the open position to ensure a thorough and effective cleaning process.
 - Use soft textile or paper cloths, soft plastic brushes made of nylon, or water spray guns.
- Do **NOT** use steel wool, wire brushes, or scouring pads as these are abrasive to the instruments.

Manual Cleaning

- Make sure all instruments are visibly clean and free from stains, wiping them carefully to remove all blood and tissue matter.
- Rinse instruments thoroughly with distilled water, paying close attention to joints and hinges as these areas can accumulate unwanted material.
- Air dry your instruments completely and use a can of compressed air to blow out any water at the joints and hinges. Then store them only in clean and dry environments.

Ultrasonic Cleaning

Ultrasonic cleaning is the most effective cleaning method. The vibrating sound waves create micron-sized bubbles in the solution that grow with the alternating pressure. When the bubbles reach a particular size, they collapse creating a force that dislodges dirt and particles, even in the smallest of crevices.

- **NOT** recommended for delicate and micro instruments.
- Follow the manufacturer's guidelines for specific instructions and cleaning cycle times. Instruments should be processed for the full recommended cycle time.
- Place instruments in the open position in the ultrasonic cleaner.
 - Do **NOT** allow instruments with sharp blades to touch other instruments.
 - Do **NOT** place dissimilar metals (stainless, copper, chrome plated) in the same cleaning cycle.
 - Make sure all instruments are completely submerged.
- After the ultrasonic cleaning cycle is complete, rinse instruments thoroughly to remove all ultrasonic cleaning solution.
- Dry instruments thoroughly with a clean towel.
- Use a spray lubricant in the hinges to minimize the risk of corrosion and maintain functionality.

Sterilization

It is important that instruments are free from all traces of organic or other matter prior to sterilization.

Steam Sterilization/Autoclaving

The autoclave process utilizes moist heat (or steam) under pressure for sterilization. The steam used must be from distilled water and free of all impurities.

- Lubricate all instruments that have any metal to metal interaction such as; scissors, rongeurs, needle holders, hemostats, and retractors. Do **NOT** use WD-40 or other industrial lubricants.
- Instruments may be autoclaved individually or in sets.
 - **Individual instruments:** Disposable wraps or sterilization pouches are ideal. Make sure the pouch size is sufficient for the instrument to be in an open (unlocked) position.
 - **Instrument sets:** Open and unlock all instruments. Place the heavier instruments on the bottom of the set when two layers are needed.
- Do **NOT** lock instruments during autoclaving. This will prevent the steam from reaching and sterilizing the metal to metal surfaces, and heat expansion during autoclaving can cause cracks in the hinge areas.
- Do **NOT** over load the autoclave chamber as this may hinder steam penetration.
- Place a towel on the bottom of the pan to absorb excess moisture during autoclaving. Make sure the towel has no detergent residue and is pH neutral if immersed in water.
- At the end of the autoclave cycle (before the drying cycle) unlock the autoclave door and open it slightly. Run the dry cycle for the recommended time period by the autoclave manufacturer.

IMPORTANT NOTE: Do **NOT** mix instruments of different or unknown alloys in the autoclave.

Please note: If the autoclave door is fully opened before the drying cycle, cold air will rush into the chamber, which can cause condensation on the instruments. This will result in water stains on the instruments.

Hot Bead Sterilization

Recommended for speed and convenience when instrument tips or blade sterilization is required. The Hot Bead Sterilizer does not use dangerous gases, flames, or chemicals. Highlights:

- Bench top set up.
- Only 20 seconds of contact required to ensure your instruments are free of pathogens and microbial contaminants.
- Can be left on all day.
- Beads reach temperature of 240° - 270°C (464° - 518°F) within 15-20 minutes heating time.

Please see page 149 for more information on the FST Hot Bead Sterilizers.

Ethylene Oxide (ETO) Sterilization

This method is recommended for instruments that will not tolerate high temperatures or moisture (e.g., catheters, cannulae, etc.). This is a process consisting of 4 primary variables; gas concentration, humidity, temperature and time. Sterilization pouches and wraps available, see pages 148 and 152.

Storage

Surgical instruments should be properly stored in a clean and dry environment. It is highly recommended to use tip protectors and instrument cases to avoid possible damage to your instruments. Instrument tip protectors are available, see page 147. Instrument cases are available, see pages 152 – 155.

Oxidation (Rust)

All FST stainless steel surgical instruments are manufactured from medical grade stainless steel under strict European standards. It is very important to properly take care of your instruments to extend their lifespan.

Although stainless steel is corrosive resistant, it can still rust or stain if handled improperly. Under unfavorable conditions instruments may oxidize because stainless steel that is exposed to physical, thermal, or chemical manipulations may lose some of its stainless properties.

Quality Control

The high quality of Fine Science Tools surgical and microsurgical instruments is the result of our relentless attention to detail. Almost every instrument we sell is manufactured by skilled European craftsmen, designed to exacting specifications made from the finest German stainless steel alloys, and forged from the strongest, lightest materials available, and tested to ensure precision performance and ergonomics.

We are dedicated to quality control, with technicians in our German office inspecting most FST instruments. Aside from checking instrument dimensions and specifications, we thoroughly inspect tip sharpness, cutting edges, springs, joints, and other various components. Only after passing our detailed inspections, instruments are approved and sealed with our "FST Inspected" sticker.

We are proud to guarantee all of our products with your 100% satisfaction. If, for any reason, you are not completely satisfied with your purchase, you may return it for a full refund.





FST Student Quality Instruments

One of the hallmarks of FST has always been to accurately assess the needs of our customers. We gather information not only from the lab, but from conferences, journals and researchers. Whether it is designing new tools or finding new applications for existing instruments, we believe our best information comes directly from you.

Our customers wanted reduced costs and quantity discounts without sacrificing the precision and quality inherent in German instruments. To meet their needs, we have developed a full line of "student" instruments. They were created for use in the classroom where students are learning proper instrument care.

Unlike our competitors, the quality of these instruments does not drop dramatically with the price. Our student line uses quality stainless steel and maintains the precision you expect from FST. In addition they carry our unconditional satisfaction guarantee while being offered at a significantly reduced price.

Not intended as a substitute for our highest quality instruments, the student line may require extra care as the alloys used are more susceptible to corrosion. All of our shipments come with an instruction pamphlet describing the use and care of surgical instruments. Visit our website at finescience.de for more information.

Features:

- Economy
- Quantity discounts
- Quality
- German craftsmanship
- Less hand finishing
- Less expensive alloys

We Proudly Stock



Fine Science Tools is proud to offer a large selection of left-handed surgical instruments to the research community. To find our left-handed instruments in this catalog, look for the “left-handed” icon on the pages below.

Scissors: pages 17, 29 and 161

Hemostatic Forceps: page 93

Needle Holders: pages 113-114

Ligation Aid: page 135



FST features a selection of scissors with larger than normal finger loops. Most of these loops are easily adjustable to fit larger fingers more comfortably. To find our large loop scissors please look for the “large loop” icon on the pages below.

Scissors: pages 19, 28 and 31



Fine Science Tools has noted which items are most frequently purchased for use in a variety of surgical procedures. To find our most popular items, look for the “most popular” icon throughout the catalog.



Fine Science Tools offers a wide selection of the latest and most popular Dumont forceps. Hand crafted in Switzerland for more than a century, these forceps are known for their consistent and uncompromised fineness. Dumont forceps come in a wide array of styles and alloys. On page 189, you will find detailed descriptions to help guide you in choosing the right Dumont forceps best suited for your needs.



Moria of France is one of the most respected and well known ophthalmic instrument manufacturers in the world, offering some of the finest surgical instruments in the industry for almost 200 years.

Only quality Swedish and German stainless alloys are selected; and many hours of highly skilled labor are put into the manufacturing process, which includes hand crafted sharpening, balancing, and polishing, often done under 40x magnification. Moria’s product line includes scissors, spring scissors, forceps, spoons, vessel clamps, and more.



This Swiss manufacturer has established itself as one of the premier suppliers of superb microsurgical instruments worldwide. Unique designs, precise instrument balance, and optimum angles gives S&T instruments the “right feel” which is important for all procedures. S&T’s product line includes forceps, needle holders, scissors, vessel clamps, sutures, vessel cannulation forceps, vessel dilators, and more.

Finding the Dumont forceps best suited for your needs:



| Alloys | Hardness | Magnetic | Temperature resistance | Autoclavable | Advantages |
|-----------------|------------|----------|------------------------|--------------|---|
| Titanium | Least Hard | No | Up to 430° C | Yes | Resistant to corrosion from nitric acid, chloride, and salt water. Titanium is 40% lighter than stainless steel. |
| Dumoxel | Hard | No | 400° C | Yes | The most popular alloy available for Dumont forceps offers the best resistance to corrosion, sulphuric environments, hydrochloric acids, and all other mineral and organic acids. |
| Inox | Harder | Yes | 400° C | Yes | Available for most Dumont forceps. Contains chromium added to carbon steel, which results in some loss of hardness but offers good stainless qualities and resistance to corrosion. |
| Dumostar | Harder | No | 500° C | Yes | More durable and corrosion resistant than the best stainless steels. Highly resistant to mineral and organic acids, and salt water. Dumostar lasts an average of four times longer than Dumoxel and Inox. Most cost effective alloy for laboratory use. |
| Carbon | Hardest | Yes | N/A | No | Extremely hard; ensuring strong tips. Easily stains and rusts without proper care. Carbon cannot be immersed in a water bath or sterilized. |

Tip profiles: Dimensions vary. See each style for specific dimensions (width x thickness).

| | |
|------------------------|--|
| Standard | Made for high precision and consistently precise work under a microscope. |
| Biology | Twice as fine as "Standard Tips." Especially produced for high precision laboratory work under the microscope. |
| Super Fine Tips | Four times finer than the "Standard Tips." These tips are extremely delicate for the finest work under the microscope. Extra care is needed for these tips as they are very fragile. |

Styles

| | | | |
|---------------|---|----------------|---|
| #2 | Straight forceps with wide yet fine tips, referred to as Mouse Laminectomy Forceps because of their popularity in breaking off delicate bone from mouse skulls. | #6 | Sharply angled, broad tips. |
| #2AP | Epoxy coated with flat wide blunt tips. | #7 | Most popular style of Dumont curved forceps with fine tips which come in several styles. |
| #3 | Long straight forceps with coarse tips. Popular in low magnification procedures. | #7B | Curved serrated tips. |
| #3C | Shorter version of #3. | AA | Strong broad tips. |
| #4 | Similar to the #5 but with broader shanks and stronger tips. | M | Mini forceps. |
| #5 | Most popular style of Dumont straight forceps with fine tips which come in several styles. | Medical | Denotes distinctive ribbed handle to maximize grip. |
| #55 | Similar to the #5 but with lighter shanks, giving the forceps a lighter spring action. | SS | Long and narrow shanks with thin tips. |
| #5CO | Similar to the #55 but with even finer shanks producing the lightest spring action and longest meeting surface of any Dumont style. | WA | One piece design with no soldering grooves allows the forceps to be thoroughly and easily cleaned preventing biofilm residue. |
| #5L | Medical #5 forceps with slide sleeve for a secure hold and retention. | | |
| #5SF | The finest tips ever produced by Dumont. | | |
| #5XL | Extra Long #5 forceps. | | |
| #5/45 | Tips angled at 45°. | | |
| #5/45C | Designed to pick up cover slips from multi-well plates. | | |
| #5/90 | Tips angled at 90°. | | |

| Item No. | Page No. | | | | | | | | | | |
|-----------------|-----------------|---------------|-----|---------------|-----|---------------|----|---------------|----|---------------|----|
| | | 10025-50..... | 52 | 10096-16..... | 49 | 11001-14..... | 87 | 11023-14..... | 88 | 11106-09..... | 83 |
| | | 10030-13..... | 100 | 10097-16..... | 49 | 11001-16..... | 87 | 11023-15..... | 88 | 11150-10..... | 80 |
| | | 10031-13..... | 100 | 10099-12..... | 105 | 11001-18..... | 87 | 11024-18..... | 91 | 11151-10..... | 80 |
| 00071-14..... | 131 | 10032-13..... | 100 | 10099-15..... | 105 | 11001-20..... | 87 | 11025-18..... | 91 | 11152-10..... | 80 |
| 00072-14..... | 131 | 10033-13..... | 100 | 10100-30..... | 53 | 11002-12..... | 86 | 11026-15..... | 89 | 11153-10..... | 80 |
| 00081-00..... | 158 | 10035-00..... | 56 | 10100-45..... | 53 | 11002-13..... | 86 | 11027-12..... | 84 | 11154-10..... | 80 |
| 00108-11..... | 75 | 10035-05..... | 56 | 10110-01..... | 52 | 11002-14..... | 86 | 11028-15..... | 89 | 11155-10..... | 80 |
| 00109-11..... | 75 | 10035-10..... | 56 | 10110-03..... | 52 | 11002-16..... | 86 | 11029-14..... | 88 | 11200-00..... | 72 |
| 00125-11..... | 136 | 10035-12..... | 56 | 10130-05..... | 107 | 11002-18..... | 86 | 11030-12..... | 85 | 11200-10..... | 72 |
| 00126-11..... | 136 | 10035-15..... | 56 | 10130-10..... | 107 | 11002-20..... | 86 | 11031-15..... | 89 | 11200-12..... | 72 |
| 00272-13..... | 77 | 10035-20..... | 56 | 10130-20..... | 107 | 11002-25..... | 86 | 11036-20..... | 87 | 11200-14..... | 72 |
| 00276-13..... | 136 | 10035-25..... | 56 | 10140-01..... | 101 | 11003-12..... | 86 | 11036-90..... | 87 | 11200-33..... | 71 |
| 00325-00..... | 130 | 10035-30..... | 56 | 10140-02..... | 101 | 11003-13..... | 86 | 11040-08..... | 79 | 11203-23..... | 71 |
| 00396-01..... | 130 | 10050-00..... | 55 | 10140-03..... | 101 | 11003-14..... | 86 | 11041-08..... | 79 | 11203-25..... | 71 |
| 00398-02..... | 130 | 10052-11..... | 55 | 10140-04..... | 101 | 11003-16..... | 86 | 11042-08..... | 79 | 11210-10..... | 71 |
| 00400-03..... | 130 | 10053-09..... | 55 | 10152-30..... | 54 | 11003-18..... | 86 | 11043-08..... | 79 | 11210-20..... | 71 |
| 00571-13..... | 139 | 10053-13..... | 55 | 10157-13..... | 54 | 11003-20..... | 86 | 11049-10..... | 80 | 11215-01..... | 41 |
| 00574-11..... | 139 | 10055-12..... | 50 | 10157-15..... | 54 | 11006-12..... | 84 | 11050-10..... | 80 | 11215-02..... | 41 |
| 00632-11..... | 75 | 10056-12..... | 50 | 10157-18..... | 54 | 11006-15..... | 78 | 11051-10..... | 80 | 11220-21..... | 70 |
| 00649-11..... | 75 | 10058-15..... | 51 | 10160-13..... | 103 | 11008-13..... | 86 | 11052-10..... | 80 | 11223-20..... | 70 |
| | | 10059-13..... | 50 | 10162-12..... | 99 | 11008-15..... | 86 | 11053-10..... | 80 | 11231-20..... | 68 |
| 10000-10..... | 60 | 10059-15..... | 51 | 10165-11..... | 102 | 11009-13..... | 86 | 11054-10..... | 80 | 11231-30..... | 68 |
| 10000-11..... | 60 | 10060-00..... | 60 | 10166-11..... | 102 | 11009-15..... | 86 | 11055-10..... | 80 | 11241-30..... | 70 |
| 10000-15..... | 60 | 10060-13..... | 60 | 10167-11..... | 102 | 11010-17..... | 91 | 11062-10..... | 81 | 11242-40..... | 70 |
| 10002-00..... | 59 | 10061-12..... | 101 | 10315-12..... | 56 | 11011-17..... | 91 | 11063-07..... | 76 | 11251-10..... | 65 |
| 10002-50..... | 59 | 10062-12..... | 101 | 10316-14..... | 56 | 11012-18..... | 91 | 11064-07..... | 79 | 11251-20..... | 65 |
| 10003-12..... | 58 | 10063-15..... | 100 | 10317-14..... | 56 | 11012-21..... | 91 | 11065-07..... | 79 | 11251-21..... | 66 |
| 10003-13..... | 58 | 10064-14..... | 101 | 10318-14..... | 56 | 11012-25..... | 91 | 11066-07..... | 79 | 11251-23..... | 65 |
| 10004-13..... | 57 | 10065-15..... | 100 | 10321-08..... | 108 | 11013-18..... | 91 | 11067-07..... | 79 | 11251-30..... | 65 |
| 10006-12..... | 61 | 10066-15..... | 100 | 10360-13..... | 108 | 11013-21..... | 91 | 11069-08..... | 79 | 11251-33..... | 67 |
| 10007-12..... | 59 | 10073-14..... | 50 | 10370-13..... | 51 | 11014-18..... | 90 | 11070-08..... | 79 | 11251-35..... | 67 |
| 10007-16..... | 59 | 10075-16..... | 49 | 10370-17..... | 108 | 11015-18..... | 90 | 11071-10..... | 81 | 11252-00..... | 63 |
| 10008-13..... | 57 | 10080-05..... | 49 | 10370-18..... | 108 | 11016-17..... | 91 | 11073-10..... | 82 | 11252-20..... | 65 |
| 10010-00..... | 58 | 10081-10..... | 49 | 10370-19..... | 108 | 11017-17..... | 91 | 11074-02..... | 82 | 11252-21..... | 66 |
| 10010-10..... | 61 | 10082-15..... | 49 | | | 11018-12..... | 84 | 11075-00..... | 82 | 11252-30..... | 65 |
| 10011-00..... | 58 | 10083-20..... | 49 | 11000-12..... | 87 | 11019-12..... | 84 | 11080-02..... | 90 | 11252-40..... | 65 |
| 10011-10..... | 61 | 10087-12..... | 104 | 11000-13..... | 87 | 11020-12..... | 84 | 11083-07..... | 76 | 11252-50..... | 63 |
| 10012-00..... | 58 | 10088-15..... | 103 | 11000-14..... | 87 | 11021-12..... | 88 | 11084-07..... | 76 | 11253-10..... | 66 |
| 10015-00..... | 58 | 10089-11..... | 104 | 11000-16..... | 87 | 11021-14..... | 88 | 11090-09..... | 76 | 11253-20..... | 64 |
| 10015-10..... | 61 | 10090-13..... | 103 | 11000-18..... | 87 | 11021-15..... | 88 | 11091-15..... | 97 | 11253-21..... | 64 |
| 10020-00..... | 57 | 10091-12..... | 104 | 11000-20..... | 87 | 11022-12..... | 84 | 11092-12..... | 97 | 11253-25..... | 64 |
| 10021-00..... | 57 | 10092-12..... | 104 | 11000-25..... | 87 | 11022-14..... | 88 | 11095-09..... | 97 | 11253-27..... | 67 |
| 10022-00..... | 57 | 10093-13..... | 104 | 11000-30..... | 87 | 11022-15..... | 88 | 11095-13..... | 97 | 11253-29..... | 64 |
| 10023-00..... | 57 | 10094-13..... | 104 | 11001-12..... | 87 | 11023-10..... | 88 | 11101-09..... | 83 | 11254-20..... | 63 |
| 10025-45..... | 52 | 10095-12..... | 49 | 11001-13..... | 87 | 11023-12..... | 88 | 11103-09..... | 83 | 11255-20..... | 65 |

| | | | | | |
|--------------------|--------------------|--------------------|-------------------|-------------------|-------------------|
| 11260-20 68 | 11700-02 82 | 12075-14 110 | 14001-14 29 | 14028-10 22 | 14085-09 15 |
| 11270-20 69 | 11700-03 82 | 12076-12 110 | 14001-16 29 | 14029-10 22 | 14086-09 27 |
| 11271-30 69 | 11700-04 82 | 12102-12 113 | 14001-18 29 | 14037-10 28 | 14088-10 18 |
| 11272-30 69 | 11800-00 78 | 12500-12 112 | 14002-12 29 | 14040-10 19 | 14090-09 16 |
| 11272-40 69 | 11800-01 78 | 12501-13 112 | 14002-13 29 | 14041-10 19 | 14090-11 16 |
| 11272-50 69 | 11900-14 78 | 12502-12 113 | 14002-14 29 | 14054-13 30 | 14091-09 16 |
| 11273-20 64 | | 12502-14 113 | 14002-16 29 | 14058-09 20 | 14091-11 16 |
| 11273-22 64 | 12001-13 112 | 12503-15 114 | 14003-12 29 | 14058-11 20 | 14094-11 16 |
| 11274-20 69 | 12002-12 113 | 12504-15 114 | 14003-13 29 | 14059-09 20 | 14095-11 16 |
| 11280-11 139 | 12002-14 113 | 12505-15 115 | 14003-14 29 | 14059-11 20 | 14101-14 31 |
| 11281-11 139 | 12003-15 114 | 12510-14 111 | 14003-16 29 | 14060-09 17 | 14105-12 25 |
| 11282-11 139 | 12004-16 114 | 12512-12 113 | 14003-18 29 | 14060-10 17 | 14106-09 28 |
| 11293-00 68 | 12004-18 114 | 12565-14 111 | 14003-20 29 | 14060-11 17 | 14107-09 28 |
| 11294-00 70 | 12005-15 115 | 12800-00 109 | 14004-12 29 | 14061-09 17 | 14108-09 28 |
| 11295-00 65 | 12010-14 111 | | 14004-13 29 | 14061-10 17 | 14110-15 34 |
| 11295-10 65 | 12018-12 118 | 13002-10 94 | 14004-14 29 | 14061-11 17 | 14110-17 34 |
| 11295-20 63 | 12020-00 121 | 13003-10 94 | 14004-16 29 | 14062-09 17 | 14111-15 34 |
| 11295-51 65 | 12020-09 121 | 13004-14 95 | 14004-18 29 | 14062-10 17 | 14111-17 34 |
| 11297-00 69 | 12022-09 121 | 13005-14 95 | 14005-12 29 | 14063-09 17 | 14116-14 33 |
| 11297-10 69 | 12023-00 121 | 13006-12 92 | 14005-13 29 | 14063-11 17 | 14116-18 33 |
| 11370-31 74 | 12028-12 118 | 13007-12 92 | 14005-14 29 | 14064-11 24 | 14117-14 33 |
| 11370-32 74 | 12029-12 118 | 13008-12 93 | 14005-16 29 | 14065-11 24 | 14117-18 33 |
| 11370-40 74 | 12030-01 120 | 13009-12 93 | 14007-14 30 | 14066-11 24 | 14130-17 30 |
| 11370-42 74 | 12030-04 120 | 13010-12 93 | 14008-14 29 | 14067-11 24 | 14131-14 31 |
| 11373-12 74 | 12030-20 120 | 13011-12 93 | 14010-15 34 | 14068-12 19 | 14160-10 17 |
| 11373-22 74 | 12030-22 120 | 13012-12 93 | 14010-17 34 | 14069-12 19 | 14161-10 17 |
| 11399-80 74 | 12030-23 120 | 13013-14 96 | 14011-15 34 | 14070-12 19 | 14171-10 28 |
| 11399-87 74 | 12035-00 120 | 13014-14 96 | 14011-17 34 | 14071-12 19 | 14173-12 25 |
| 11412-11 73 | 12040-01 118 | 13015-14 96 | 14012-15 35 | 14072-10 27 | 14184-09 15 |
| 11413-11 73 | 12040-02 118 | 13018-14 95 | 14012-17 35 | 14074-09 23 | 14185-09 15 |
| 11445-12 73 | 12040-03 118 | 13019-14 95 | 14013-15 35 | 14074-11 23 | 14200-21 35 |
| 11480-11 73 | 12050-01 117 | 13020-12 92 | 14013-17 35 | 14075-09 23 | 14370-22 18 |
| 11506-12 84 | 12050-02 117 | 13021-12 92 | 14014-17 35 | 14075-11 23 | 14370-23 18 |
| 11602-14 86 | 12050-03 117 | 13108-12 93 | 14015-17 35 | 14076-09 26 | 14501-14 30 |
| 11602-16 90 | 12050-10 117 | 13109-12 93 | 14016-14 33 | 14077-09 24 | 14502-14 30 |
| 11608-15 86 | 12050-20 117 | 13111-12 94 | 14016-18 33 | 14077-10 24 | 14504-14 30 |
| 11616-15 85 | 12051-08 116 | | 14017-14 33 | 14078-10 22 | 14505-14 30 |
| 11617-12 85 | 12051-09 116 | 14000-12 29 | 14017-18 33 | 14079-10 22 | 14508-15 32 |
| 11626-11 67 | 12051-10 116 | 14000-13 29 | 14018-13 32 | 14080-11 27 | 14509-15 32 |
| 11627-12 85 | 12051-11 116 | 14000-14 29 | 14018-14 32 | 14081-09 26 | 14510-15 34 |
| 11650-10 80 | 12060-01 109 | 14000-16 29 | 14018-18 32 | 14082-09 26 | 14510-17 34 |
| 11651-10 80 | 12060-02 109 | 14000-18 29 | 14019-13 32 | 14083-08 15 | 14511-15 34 |
| 11652-10 80 | 12061-01 109 | 14000-20 29 | 14019-14 32 | 14084-08 15 | 14511-17 34 |
| 11700-00 82 | 12061-02 109 | 14001-12 29 | 14019-18 32 | 14084-09 15 | 14512-15 34 |
| 11700-01 82 | 12075-12 110 | 14001-13 29 | 14024-14 33 | 14085-08 15 | 14512-17 34 |

| | | | | | |
|------------------|------------------|------------------|------------------|-------------------|-------------------|
| 14518-14..... 32 | 15017-10.....10 | 16001-15..... 39 | 17003-03.....123 | 18020-00..... 117 | 18053-28..... 133 |
| 14518-18..... 32 | 15018-10..... 4 | 16002-18..... 37 | 17004-03.....123 | 18020-01..... 117 | 18054-28..... 133 |
| 14519-14..... 32 | 15019-10..... 4 | 16004-16..... 39 | 17004-05.....124 | 18020-02..... 117 | 18055-01.....132 |
| 14519-18..... 32 | 15020-15..... 6 | 16005-16..... 39 | 17005-03.....123 | 18020-03..... 117 | 18055-02.....132 |
| 14531-09.....31 | 15021-15..... 6 | 16012-12..... 38 | 17005-04.....124 | 18020-20..... 117 | 18055-03.....132 |
| 14558-09.....21 | 15023-10..... 8 | 16015-17..... 36 | 17006-05.....124 | 18020-30..... 117 | 18055-04.....132 |
| 14558-11.....21 | 15024-10..... 8 | 16016-17..... 36 | 17007-08.....124 | 18020-40..... 117 | 18055-05.....132 |
| 14559-09.....21 | 15025-10..... 8 | 16020-14..... 36 | 17008-07.....125 | 18020-50..... 117 | 18055-06.....132 |
| 14559-11.....21 | 15027-18.....11 | 16021-14..... 36 | 17009-07.....125 | 18020-60..... 117 | 18056-14.....132 |
| 14568-09..... 20 | 15028-18.....11 | 16022-15..... 37 | 17009-08.....125 | 18020-70..... 117 | 18057-14.....132 |
| 14568-12..... 20 | 15030-14.....13 | 16023-15..... 37 | 17010-07.....125 | 18025-10..... 77 | 18060-20.....141 |
| 14569-09..... 20 | 15031-14.....13 | 16025-14.....47 | 17010-10.....126 | 18026-10..... 77 | 18061-10.....141 |
| 14569-12..... 20 | 15032-08.....14 | 16030-12..... 44 | 17011-10.....127 | 18030-30..... 117 | 18061-15.....141 |
| 14574-09..... 23 | 15032-13.....14 | 16030-16..... 44 | 17012-11.....128 | 18030-40..... 117 | 18061-18.....141 |
| 14574-11..... 23 | 15033-09..... 8 | 16044-10..... 44 | 17012-13.....128 | 18030-50..... 117 | 18061-20.....141 |
| 14575-09..... 23 | 15036-14.....13 | 16050-15..... 45 | 17017-10.....127 | 18030-60..... 117 | 18061-22.....141 |
| 14575-11..... 23 | 15037-14.....13 | 16060-11.....41 | 17018-11.....128 | 18030-70..... 117 | 18061-24.....141 |
| 14958-09.....21 | 15040-11..... 9 | 16101-10..... 43 | 17020-17.....122 | 18030-80..... 117 | 18061-50.....141 |
| 14958-11.....21 | 15042-11..... 9 | 16102-11..... 43 | 17021-13.....122 | 18035-01.....157 | 18061-75.....141 |
| 14959-09.....21 | 15070-08..... 4 | 16104-14..... 46 | 17022-13.....122 | 18035-02.....157 | 18062-12.....135 |
| 14959-11.....21 | 15071-08..... 4 | 16104-19..... 46 | 17023-13.....122 | 18035-03.....157 | 18062-13.....135 |
| | 15110-08.....12 | 16105-16..... 46 | 17370-53.....124 | 18035-05.....157 | 18063-13.....135 |
| 15000-00..... 3 | 15111-08.....12 | 16106-14..... 46 | | 18035-35.....157 | 18067-11..... 99 |
| 15000-01..... 5 | 15123-12..... 6 | 16107-14..... 40 | 18000-00.....156 | 18035-50.....157 | 18080-01.....134 |
| 15000-02..... 5 | 15124-12..... 6 | 16109-14..... 40 | 18000-01.....156 | 18035-80.....157 | 18080-02.....134 |
| 15000-03..... 3 | 15300-00.....14 | 16120-14..... 36 | 18000-02.....156 | 18036-19.....157 | 18080-03.....134 |
| 15000-04..... 3 | 15370-50..... 7 | 16121-14..... 36 | 18000-03.....156 | 18036-22.....157 | 18090-00.....158 |
| 15000-08..... 3 | 15370-52..... 7 | 16130-15..... 45 | 18000-04.....156 | 18036-24.....157 | 18105-01.....157 |
| 15000-10..... 3 | 15371-92.....11 | 16140-11.....42 | 18000-10.....138 | 18038-45.....133 | 18105-03.....157 |
| 15000-11..... 5 | 15396-00..... 5 | 16141-11.....42 | 18000-15.....144 | 18039-45.....133 | 18131-12.....136 |
| 15000-12..... 5 | 15396-01..... 5 | 16142-11.....42 | 18000-18.....159 | 18040-00.....134 | 18132-12.....136 |
| 15001-08..... 3 | 15400-12..... 6 | 16144-13..... 44 | 18000-20.....159 | 18040-11.....130 | 18133-12.....136 |
| 15002-08..... 3 | 15401-12..... 6 | 16150-24.....47 | 18000-30.....150 | 18040-14.....131 | 18144-30.....133 |
| 15003-08..... 4 | 15514-12..... 9 | 16152-11.....42 | 18000-35.....163 | 18040-22.....130 | 18155-13..... 81 |
| 15004-08..... 4 | 15610-08..... 5 | 16152-12.....42 | 18000-45.....149 | 18040-33.....130 | 18200-01.....129 |
| 15005-08..... 4 | 15615-08..... 5 | 16152-15.....42 | 18000-46.....149 | 18050-28.....133 | 18200-02.....129 |
| 15006-09..... 8 | 15617-08..... 5 | 16220-14..... 36 | 18000-50.....149 | 18050-35.....133 | 18200-03.....129 |
| 15007-08..... 4 | 15650-11.....10 | 16221-14..... 36 | 18000-51.....149 | 18050-50.....133 | 18200-04.....129 |
| 15008-08..... 4 | 15651-11.....10 | | 18004-18.....159 | 18051-28.....133 | 18200-05.....129 |
| 15009-08..... 7 | 15750-11..... 7 | 17000-01.....123 | 18004-23.....159 | 18051-35.....133 | 18200-06.....129 |
| 15010-11.....11 | 15751-11..... 7 | 17000-02.....123 | 18004-27.....159 | 18051-50.....133 | 18200-07.....129 |
| 15011-12..... 9 | 15800-00.....12 | 17000-03.....123 | 18004-50.....159 | 18052-01.....133 | 18200-08.....129 |
| 15012-12..... 9 | 15800-01.....12 | 17000-04.....123 | 18010-00.....156 | 18052-02.....133 | 18200-09.....129 |
| 15013-12..... 9 | | 17001-07.....126 | 18010-01.....156 | 18052-03.....133 | 18200-10.....129 |
| 15015-11.....10 | 16000-14..... 38 | 17002-02.....123 | 18010-02.....156 | 18052-12.....135 | 18200-11.....129 |

| | | | | |
|--------------------|--------------------|--------------------|--------------------|--------------------|
| 18200-12 129 | 20830-05 155 | 26007-03 107 | 29015-50. 145, 170 | 91110-10 177 |
| 18200-20 129 | 20840-02 153 | 26007-04 107 | 29025-01 164 | 91113-10 177 |
| 18200-50 129 | 20840-03 153 | 26007-05 107 | 29025-02 164 | 91115-10 177 |
| 18320-11 133 | 20842-03 153 | 26016-12 106 | 29026-00 164 | 91117-10 177 |
| 18374-43 133 | 20850-00 153 | 26018-17 106 | 29027-00 164 | 91121-12 175 |
| 18374-44 133 | 20850-10 153 | 26029-10 83 | 29051-45 144 | 91127-12 175 |
| 18403-11 139 | 20890-51 153 | 26030-10 83 | 29055-00 144 | 91150-20 176 |
| 18406-11 139 | 20890-72 153 | 26100-00.. 48, 106 | 29055-12 144 | 91197-00 176 |
| 18406-13 139 | | | 29060-00 147 | 91201-13 178 |
| 18555-01 132 | 23005-10 119 | 27000-01 165 | 29060-01 147 | 91308-12 178 |
| 18555-02 132 | | 27000-10 165 | 29060-02 147 | 91309-12 178 |
| 18555-03 132 | 24201-00 143 | | 29060-03 147 | 91400-12 173 |
| 18555-04 132 | 24201-01 143 | 28000-07 148 | 29060-04 147 | 91400-14 173 |
| 18601-15 137 | 24212-01 142 | 28000-10 148 | 29060-05 147 | 91401-12 173 |
| 18602-15 137 | 24212-02 142 | 28000-12 148 | 29060-06 147 | 91401-14 173 |
| 18603-14 137 | 24214-02 142 | 28001-00 150 | 29066-00 147 | 91402-12 173 |
| | 24215-02 142 | 28001-02 150 | 29066-01 147 | 91402-14 173 |
| 19003-00 165 | 24220-00 143 | 28011-00 171 | 29066-02 147 | 91413-14 174 |
| 19003-01 165 | 24220-10 143 | 28011-01 171 | 29066-03 147 | 91460-11 173 |
| 19007-05 159 | 24220-50 143 | 28011-20 171 | 29066-04 147 | 91461-11 173 |
| 19007-07 159 | 26000-25 107 | 28015-15 152 | 29071-01 146 | 91500-09 173 |
| 19007-09 159 | 26000-30 107 | 28015-25 171 | 29071-02 146 | 91501-09 173 |
| 19007-14 159 | 26000-35 107 | 28020-20 152 | 29071-03 146 | 91604-09 174 |
| 19007-21 159 | 26000-40 107 | 28020-28 170 | 29071-04 146 | 91606-07 179 |
| 19007-29 159 | 26000-45 107 | 28030-02 167 | 29071-05 146 | 91706-05 179 |
| 19008-07 159 | 26000-50 107 | 28030-03 167 | 29071-06 146 | 91815-11 175 |
| 19008-09 159 | 26000-55 107 | 28030-04 167 | 29071-07 146 | |
| 19008-14 159 | 26000-60 107 | 28030-10 167 | 29071-08 146 | |
| 19009-00 48 | 26000-65 107 | 28030-20 168 | 29080-00 146 | |
| 19010-00 48 | 26000-70 107 | 28030-25 168 | | |
| 19010-10 48 | 26001-25 107 | 28040-30 168 | 30051-10 161 | |
| | 26001-30 107 | 28050-30 169 | 30076-14 160 | |
| 20020-00 154 | 26001-35 107 | 28050-35 169 | 30085-15 162 | |
| 20311-21 154 | 26001-40 107 | 28080-00 167 | 30085-30 162 | |
| 20325-00 151 | 26001-45 107 | 28080-90 168 | 30087-00 163 | |
| 20325-10 151 | 26001-50 107 | 28090-01 166 | 30087-20 163 | |
| 20350-00 151 | 26001-55 107 | 28090-30 166 | 30090-06 160 | |
| 20810-01 152 | 26001-60 107 | 28090-40 166 | | |
| 20810-02 152 | 26001-65 107 | 28090-70 166 | 37000-00 161 | |
| 20820-00 152 | 26001-70 107 | | 37500-00 161 | |
| 20830-00 155 | 26002-10 107 | 29000-00 . 72, 145 | | |
| 20830-01 155 | 26002-15 107 | 29000-10. 145, 170 | 91003-12 179 | |
| 20830-02 155 | 26002-20 107 | 29008-01 144 | 91100-12 175 | |
| 20830-03 155 | 26007-01 107 | 29008-12 144 | 91100-16 175 | |
| 20830-04 155 | 26007-02 107 | 29008-22 145 | 91106-12 175 | |

Alphabetical Index

A

| | |
|---------------------------------------|---------|
| Absorption spears | 157 |
| <i>Adson</i> forceps | 84-85 |
| <i>Adson</i> | 84 |
| <i>Adson-Brown</i> | 85 |
| <i>Adson DeBakey</i> | 85 |
| <i>Adson-Graefe</i> | 85 |
| Micro <i>Adson</i> | 84 |
| Micro <i>Adson</i> Fenestrated | 84 |
| <i>Agricola</i> retractor | 124 |
| <i>Allis</i> hemostatic forceps | 97 |
| <i>Alm</i> retractors | 125-126 |
| Applicators | |
| Micro serrefine | 130-132 |
| Suture clips | 118-121 |
| Applying forceps, clamp | 131-132 |
| Arc blade | 56 |
| Arteriotomy knives | 51-52 |
| Artery scissors | 27 |
| Austin Chisel | 49 |
| AutoClip® System | 121 |

B

| | |
|--|-------|
| Baby-Beyer | 37 |
| <i>Baby-Mixer</i> hemostatic forceps | 96 |
| <i>Backhaus</i> towel forceps | 97 |
| Balanced Instruments | 137 |
| Ball Tipped | |
| Scissors | 27 |
| Spring Scissors | 8 |
| <i>Beebee</i> bone scissors | 44 |
| <i>Beyer</i> rongeurs | 37 |
| <i>Biemer</i> spring scissors | 14 |
| <i>Bishop-Harman</i> forceps | 79 |
| <i>Bonn-Strabismus</i> scissors | 15 |
| Blade | |
| Breakers | 55 |
| Holders | 52-61 |
| Blades | |
| Breakable | 55 |
| Ceramic | 52 |
| Scalpel | 52-61 |
| <i>Blair</i> retractor | 122 |
| <i>Boehler</i> bone cutter | 45 |

Bone

| | |
|----------------------------|-------|
| Cutters | 40-47 |
| Delicate scraper | 49 |
| Forceps | 41 |
| Nipper | 43 |
| Pliers | 47 |
| Rongeurs | 36-39 |
| Scissors | 44 |
| Scissors, Student | 173 |
| Screws, forceps | 48 |
| Screws, self-tapping | 48 |
| Shears | 47 |
| Wax | 48 |

Bone cutters

| | |
|---------------------------|----|
| <i>Beebee</i> | 44 |
| Bone Trimmers | 40 |
| <i>Boehler</i> | 45 |
| Cartilage Cutter | 40 |
| <i>Cleveland</i> | 46 |
| Dumont carbon steel | 41 |
| Dumont epoxy coated | 41 |
| <i>Liston</i> | 46 |
| <i>Littauer</i> | 42 |
| Malleus Nipper | 42 |
| Offset Bone Nipper | 43 |
| Skull Flap | 45 |
| Spring Scissors | 44 |
| Tungsten Carbide | 44 |

Bone Nipper

| | |
|--|--------|
| 43 | |
| <i>Bonn</i> | |
| Artery | 27 |
| Forceps | 76 |
| Micro probes | 100 |
| Scissors | 15, 27 |
| Strabismus | 15 |
| Book and DVD- <i>Suturing Principles</i> | 119 |
| <i>Bowman</i> retractor | 126 |
| <i>Boynton</i> rongeur | 38 |
| Bulldog clamps | 133 |
| Burrs | 159 |

C

Calipers

| | |
|--------------------------|---------|
| <i>Castroviejo</i> | 163 |
| electronic | 163 |
| vernier | 163 |
| Cane blade | 56 |
| Cannulation aids | 135-139 |

Cartilage Cutter

| | |
|----|--|
| 40 | |
|----|--|

Castroviejo

| | |
|-----------------------|----------|
| Caliper | 163 |
| Needle holders | 109, 111 |
| Spring scissors | 10 |

Cauterizers, vessel

| | |
|-----|--|
| 156 | |
|-----|--|

CeramaCut, scissors

| | |
|----|--|
| 21 | |
|----|--|

Ceramic

| | |
|-----------------------|--------|
| About | 183 |
| Blades | 52 |
| Dumont forceps | 63, 69 |
| Scissors | 21 |
| Spring scissors | 7 |
| Titanium | 10 |

Chisels

| | |
|--------------------|----|
| Austin | 49 |
| Dissecting | 49 |
| Circle knife | 51 |

Clamps

| | |
|------------------------------------|--------------|
| Applying forceps | 131-132 |
| Bulldog Artery Spring Clamps | 133 |
| Bulldog Type Serrefines | 133 |
| Dietrich Bulldog Clamps | 133 |
| Double micro clamps | 130 |
| Mini Serrefines | 133 |
| Moria | 133 |
| S&T | 130 |
| Schwartz Micro Serrefines | 133 |
| Silver Neuro Clips | 134 |
| Titanium | 132 |
| Vascular | 130, 132-133 |
| Vascular Occluders | 134 |

Cleveland bone cutters

| | |
|----|--|
| 46 | |
|----|--|

Clip On LED Light

| | |
|-----|--|
| 168 | |
|-----|--|

Clipper style scissors

| | |
|----|--|
| 14 | |
|----|--|

Cohan-Vannas spring scissors

| | |
|---|--|
| 5 | |
|---|--|

Colibri retractor

| | |
|-----|--|
| 123 | |
|-----|--|

Colibri retractor (mini)

| | |
|-----|--|
| 123 | |
|-----|--|

Combination Probe and Spatula

| | |
|-----|--|
| 103 | |
|-----|--|

Container-Plastic

| | |
|-----|--|
| 153 | |
|-----|--|

Corers, sample

| | |
|-----|--|
| 157 | |
|-----|--|

Cover glass forceps

| | |
|----|--|
| 82 | |
|----|--|

Cover slip forceps

| | |
|----|--|
| 67 | |
|----|--|

Crile hemostatic forceps

| | |
|----|--|
| 95 | |
|----|--|

Crile-Wood needle holders

| | |
|-----|--|
| 114 | |
|-----|--|

Curettes, micro

| | |
|----|--|
| 49 | |
|----|--|

- D**
- DeBakey* forceps..... 85
 - Decapitation scissors.....35
 - Demagnetizer.....144
 - Diamond knife.....53
 - Dietrich* bulldog clamps 133
 - Dilator, vessel.....136-139
 - Disposable safety scalpels 60-61
 - Disposable scalpel box.....59
 - Dissecting knives.....49-51
 - Double-Ended Micro Spatula.....104
 - Double Micro Clamps130
 - Double pronged tissue pick.....99
 - Double tip protectors147
 - Dowell* spring scissors9
 - Dressing forceps.....80, 86-87
 - Dumont
 - Bone Cutter41
 - Ceramic63, 69
 - Coverslip.....67
 - Epoxy70-71
 - Forceps41, 63-72,139
 - Forceps repair kit72, 145
 - Forceps sharpening stones.....72, 145
 - Laminectomy70
 - Mini Forceps.....72
 - Slide Lock67
 - Super Fine Tip63
 - Teflon.....67
 - Titanium65, 69
 - Tweezers41, 63-72,139
 - Dura cutting knife.....50
 - Dura hook.....99
- E**
- Ear
 - Punches142
 - Tags143
 - Tattoo system143
 - Electronic timers.....165
 - Etched micro needles107
 - Eschenbach magnifiers.....166, 168, 170-171
 - EVO
 - Forceps78
 - Needle holder.....109
 - Spring scissors.....12
 - Extra Fine *Bonn*15
 - Explorers.....101
- F**
- Feeding needles141
 - File set.....160
 - Filters, sterilization containers153
 - Fine
 - Bonn.....15
 - Forceps73-79
 - Iris Scissors16
 - Scissors15-28
 - Spring scissors.....3-14
 - Fine Hemostat92
 - Fixation forceps, *Pierse*.....81
 - Fomon* retractor122
 - Forceps
 - Adson*.....84-85
 - Adson-Brown*.....85
 - Adson DeBakey*.....85
 - Adson-Graefe*85
 - Applying and removing.....118
 - Bishop-Harman*.....79
 - Bone.....41
 - Bonn*76
 - Cannulation139
 - Ceramic63, 69
 - Cover glass.....82
 - Cover slip.....67
 - Cross action82
 - Dressing80, 86-87
 - Dumont.....41, 63-72,139
 - Epoxy coated.....41, 70-71
 - EVO78
 - Fine73-79
 - Fixation.....81
 - Gerald*.....90
 - Gillies*.....89
 - Graefe*80
 - Grasping78
 - Hemostatic.....92-97
 - Insect handling.....83
 - London90
 - Micro63-76
 - Mirror Finish.....65, 73, 76
 - Moria74
 - Mouse laminectomy70
 - Mouse handling87
 - Narrow Pattern86
 - Octagon.....79
 - Organ holding.....83
 - O-rings.....72
 - Pierse* fixation81
 - Pin & bone screw holding.....48, 106
 - Plastic82
 - Potts-Smith*.....91
 - Repair kit72, 145
 - Ring.....83
 - Russian*.....89
 - S&T75, 77, 139
 - Semken*.....86
 - Standard Pattern.....87
 - Student.....175-177
 - SuperGrip75
 - Suture tying.....76-77
 - Taylor91
 - Titanium65, 69, 80, 86, 90
 - Tungsten carbide.....84
 - Vetro Grasping78
 - Vial.....78
 - Friedman* rongeur.....38
 - Friedman-Pearson* rongeur36
- G**
- Galilean Loupes169
 - Gavage feeding needles.....141
 - Gelpi* retractor127
 - GenoPunch.....142
 - Gerald* forceps90
 - Gillies* forceps.....89
 - Gold wire contacts165
 - Goldstein* retractor123
 - Graefe* forceps80
 - Graefe* knife50
 - Grasping forceps78
 - Grease, silicone144
 - Gross anatomy
 - Knives.....54
 - Probe103
 - Scalpel.....60
 - Scissors29-35
 - Guthrie* retractor122
- H**
- Halsey* needle holders112
 - Halsted-Mosquito* hemostatic forceps93
 - Handles, scalpel57-61
 - Hardened Fine Iris Scissors.....16
 - Hartman* hemostatic forceps94
 - Headband magnifier167

| | | | | | |
|-------------------------------------|--------------|---|------------|---|----------|
| Headband, spectacles..... | 168 | Oil and Oil Pen..... | 144 | Galilean Loupes..... | 169 |
| <i>Heiss</i> retractor..... | 127 | Tape, identification..... | 146 | Headband..... | 167 |
| Hemostatic forceps | | Tip protectors..... | 147 | Interchangeable Headset with LED..... | 167 |
| Allis Forceps..... | 97 | Iridectomy scissors..... | 3-14 | Spectacles..... | 166-169 |
| Baby-Mixer..... | 96 | Iris Spatulae..... | 104 | Stands..... | 170-171 |
| Backhaus Towel Forceps..... | 97 | K | | Scribolux..... | 170 |
| Crile..... | 95 | <i>Kaye</i> scissors..... | 28 | Vario Flex..... | 171 |
| Fine..... | 92 | <i>Kelly</i> hemostatic forceps..... | 95 | Malleus nipper..... | 42 |
| Halsted-Mosquito..... | 93 | Knives | | Mandrel..... | 159 |
| Hartman..... | 94 | Circle..... | 51 | Manipler®, skin stapler..... | 120 |
| Hill..... | 94 | Diamond..... | 53 | Manual and DVD, <i>Suturing Principles</i> and <i>Techniques in Laboratory Animals</i> | 119 |
| Kelly..... | 95 | Dura cutting..... | 50 | Marker, skin..... | 150 |
| Left-handed..... | 93 | Gross anatomy (blade)..... | 60 | Mat, silicone..... | 153 |
| Micro-Mosquito..... | 93 | Micro..... | 50-52 | <i>Mathieu</i> needle holder..... | 111 |
| Providence-Hospital..... | 96 | Sichel..... | 50 | Max Detail spectacles..... | 168 |
| Smooth..... | 92 | Stone age..... | 52 | <i>Mayo</i> scissors..... | 34 |
| Student..... | 178 | <i>Von Graefe</i> | 50 | <i>Mayo-Hegar</i> needle holder..... | 114 |
| Ultra Fine..... | 92 | L | | <i>Mayo-Noble</i> scissors..... | 35 |
| <i>Hill</i> hemostatic forceps..... | 94 | <i>LaGrange</i> ToughCut scissors..... | 25 | <i>Mayo-Stille</i> scissors..... | 35 |
| Hippocampal dissecting tools..... | 105 | Laminectomy forceps, mouse..... | 70 | <i>Metzenbaum</i> scissors | |
| Holders | | Large Loops..... | 19, 28, 31 | Baby scissors..... | 32 |
| Blade..... | 52-61 | Left-handed | | Scissors..... | 33 |
| Ceramic blade..... | 52 | Fine scissors..... | 17 | ToughCut <i>Metzenbaum</i> | 33 |
| Micro needle..... | 109-110 | Hemostatic forceps..... | 93 | Tungsten Carbide <i>Metzenbaum Fino</i> | 32 |
| Needle..... | 109-115, 178 | Ligation aid..... | 135 | <i>Michel</i> suture clips..... | 118 |
| Pin..... | 106, 179 | Needle holders..... | 113-114 | Micro- | |
| Scalpel blade..... | 52-61 | Surgical scissors..... | 29 | Cannulation System..... | 138 |
| Hooks | | Utility scissors..... | 161 | Curettes..... | 49 |
| Blue Y-Hook..... | 102 | <i>Lempert</i> rongeur..... | 39 | Dissecting knives..... | 50-52 |
| Micro..... | 101-102 | Lens paper..... | 145, 170 | Dissection scissors..... | 3-14 |
| Spinal cord..... | 99 | <i>Lexer-Baby</i> scissors..... | 22 | Forceps..... | 63-76 |
| Hot bead sterilizers..... | 149 | Ligation aid..... | 135 | Hooks..... | 101-102 |
| I | | Ligature scissors..... | 26 | Needles, etched..... | 107 |
| Identification, animal | | <i>Lister</i> scissors..... | 31 | Needle holders..... | 109-110 |
| Tattoo system..... | 143 | <i>Liston</i> gross anatomy cutter..... | 46 | Needles and sutures..... | 116-117 |
| Ear punches..... | 142 | <i>Littauer</i> bone cutter..... | 42 | Probes..... | 100-102 |
| Ear tags..... | 143 | Live Insect Handling Forceps..... | 83 | Rongeurs..... | 36 |
| Insect | | Lubricant, silicone..... | 144 | Serrefine applicators..... | 131-132 |
| Handling forceps..... | 83 | <i>Luer</i> rongeur..... | 39 | Serrefines..... | 130, 132 |
| Pins..... | 107 | M | | Spatulae..... | 102-104 |
| Insert | | Magnetic sterilization mat..... | 151 | Micro-Mosquito Hemostat..... | 93 |
| Pin holders..... | 106, 179 | Magnifiers | | <i>Mini-Bierner</i> spring scissors..... | 14 |
| Pins..... | 107 | Eschenbach Clip On LED Light..... | 168 | Mini-Colibri retractor..... | 123 |
| Instrument | | Flex..... | 171 | Mini-Lister..... | 31 |
| Beaker..... | 158 | | | <i>Mini-Vannas</i> spring scissors..... | 5 |
| Cases..... | 152-155 | | | Minutien pins..... | 107 |
| Holding spring..... | 158 | | | | |

- Mirror finish
 Cutting spoon..... 108
 Forceps 65, 73
 Micro spatula 104
 Suture tying forceps 76
- Moria
 Forceps 74
 Instrument case 155
 Retractors..... 124
 Scissors 18
 Spoons..... 108
 Spring scissors..... 11
 Vascular clamps 133
- Mosquito hemostatic forceps..... 93
- Mouse
 Feeding needles 141
 Laminectomy forceps..... 70
 Handling forceps 87
- N**
 Narrow Pattern Forceps..... 86
- Needle Holders
 Castroviejo 109
 Castroviejo with Tungsten Carbide Jaws 109
 Crile-Wood 114
 EVO 109
 Halsey..... 112
 Halsey with Tungsten Carbide Jaws 112
 Mathieu..... 111
 Mayo-Hegar 114
 Needle Holder with Suture Cutter 110
 Olsen-Hager with Suture Cutter 113
 Round Handled..... 110
 Ryder Mini-Select Needle Holder 115
 Slim Elongated Needle Holder 115
- Needles
 Etched, micro..... 107
 Feeding..... 141
- Micro needles and sutures 116
- Neuro punches..... 157
- Neuro clips, silver..... 134
- Noyes spring scissors..... 9
- Nylon suture thread 117
- O**
 Obsidian scalpels..... 52
 Occluders, vascular 134
 Octagon Forceps..... 79
- Offset Bone Nipper 43
- Oil, instrument 144
- O-rings for forceps 72
- Olsen-Hegar* needle holders 113
- Optical cleaning kit..... 145, 170
- Organ holding forceps..... 83
- P**
Pascheff-Wolff spring scissors..... 11
Pearson rongeur..... 36
- Pen
 Oil..... 144
 Skin Marker 150
- Perforated Spoons..... 108
- Pick
 Double Pronged Pick 99
Pierson fixation forceps..... 81
- Pin holders 106
- Pins
 Etched Tungsten Micro Needles 107
 Insect..... 107
 Insert 107
 Minutien 107
- Plastic cases 152-155
- Plastic forceps 82
- Plastic sterilization container 153
- Potts-Smith* forceps 91
- Pouches, sterilization 148
- Probes
 Bonn Micro Probes..... 100
 Combination Probe and Spatula 103
 Gross Anatomy Probe 103
 Micro Hooks 101-102
 Micro Points 100, 102
 Probes and Explorer..... 101
 Vessel Dilating Probe..... 103
- Providence-Hospital* hemostatic forceps..... 96
- Punches
 Ear..... 142
 Neuro..... 157
- R**
 Repair kit, forceps 72, 145
- Retractors
 Agricola 124
 Alm Retractors 125
 Blade..... 123-125
 Blair..... 122
- Bowman*..... 126
- Colibri 123
- Fine Adjustable Wire Retractor 124
- Fomon 122
- Heiss..... 127
- Gelpi 127
- Goldstein 123
- Guthrie 122
- Large..... 124-129
- Mini-Goldstein 123
- Mini-Colibri 123
- Moria 124
- Mouth 125
- Slide..... 123
- Small..... 122-123
- Speculum..... 124
- Spring Loaded 124
- Student..... 179
- Systems 129
- Weitlaner-Locktite 128
- Wullstein 128
- Ring forceps..... 83
- Rongeurs
 Baby-Beyer..... 37
 Beyer..... 37
 Bone..... 36-39
Boynton..... 38
 Friedman..... 38
Friedman-Pearson..... 36
Lempert..... 39
Luer 39
 Micro 36
Pearson..... 36
- Round Handled
 Needle holder..... 110
 Spring scissors 6
 Suture tying forceps 76-77
- Rulers
 Label Tape 164
 Steel 162
- Russian* forceps 89
- S**
 S&T
 Cannulation forceps..... 139
 Forceps..... 75, 77, 131, 136, 139
 Instrument beaker..... 158
 Micro needles and suture..... 116

| | | | | | |
|---------------------------------------|--------------|---|---------------------------|--|------------|
| SuperGrip forceps | 75 | Student | 173-174 | <i>Biemer</i> | 14 |
| Suture tying forceps | 77 | Student Lister | 174 | Bone Cutter | 44 |
| Vascular clamps | 130 | Surgical | 29-35 | <i>Bonn</i> | 15 |
| Vessel dilator | 136 | Titanium | 5 | <i>Castroviejo</i> | 10 |
| Safety scalpel | | ToughCut | 6, 15, 20, 25, 30, 33-34 | Ceramic coated | 7 |
| Blade cartridges | 61 | ToughCut with tungsten carbide | 21 | Clipper Scissors II | 14 |
| Disposable | 60 | Tungsten carbide | 9, 20, 21, 23, 30, 32, 34 | <i>Cohan-Vannas</i> | 5 |
| Handle | 61 | Utility | 161 | <i>Dowell</i> | 9 |
| Sample corers | 157 | Vitrectomy | 13 | EVO Spring Scissors | 12 |
| Saw, Circular | 159 | Walton | 24 | Extra fine | 3-5, 12-13 |
| Scalpel | | Screwdrivers | 160-161 | Iridectomy | 3-14 |
| Blade handles | 52-61 | Screws, self-tapping bone | 48 | <i>Mini-Vannas</i> | 3 |
| Blade removers | 59 | Secure scalpel handle | 58 | Miniature Vannas | 5 |
| Blades | 52-61 | Self closing forceps | 73 | Moria | 5, 7, 11 |
| Ceramic blades | 52 | Self Holding Pin and Bone Screw Forceps | 48, 106 | <i>Noyes</i> | 9 |
| Disposal Box | 59 | <i>Semken</i> forceps | 86 | <i>Pascheff-Wolff</i> | 11 |
| Gross anatomy | 60 | Serrefines | 132, 133 | Round Handled | 6 |
| Safety Scalpels | 60-61 | Sharpening stones | 144-145 | Serrated | 4, 6 |
| Stone age | 52 | <i>Shea</i> scissors | 25 | Student <i>Vannas</i> | 173 |
| <i>Schwartz</i> micro serrefine | 133 | Shears, bone | 47 | Titanium Vannas | 5 |
| Scissors | | Silicone lubricant | 144 | ToughCut | 6 |
| Bone | 44 | Silicone mats | 151 | Trident II | 12 |
| <i>Bonn</i> | 15, 27 | Silicone tips, forceps | 87 | <i>Vannas</i> | 3-7, 173 |
| CeramaCut | 7, 21 | Silk sutures | 117 | <i>Vannas-Miniature</i> | 5 |
| Clipper | 14 | Skin marker | 150 | <i>Vannas-Tubingen</i> | 4 |
| Decapitation | 35 | Skin staplers | 120-121 | <i>Vannas-Wolff</i> | 7 |
| Dissector | 26 | Skull flap cutter | 45 | Vessels | 14 |
| <i>Dowell</i> | 9 | Slide retractors | 123 | Vitrectomy | 13 |
| EVO | 12 | Spatulae | | <i>Wecker</i> | 11 |
| Fine | 15-28 | Combination Probe and Spatula | 103 | <i>Wescott</i> | 10 |
| <i>Kaye</i> | 28 | Double-Ended Micro Spatula | 104 | Spring, instrument holding | 158 |
| <i>LaGrange</i> | 25 | Hippocampal Dissecting Tool | 105 | Stage micrometers | 164 |
| Large loops | 19, 28, 31 | Iris Spatulae | 104 | Standard Pattern Forceps | 87 |
| Left-handed | 17, 29, 161 | Micro Spatula | 102, 104 | Standard Pattern Scissors | |
| <i>Lexer-Baby</i> | 22 | Mini Hippocampal Dissecting Tool | 105 | Large Loops | 31 |
| Ligature | 26 | Mirror Finish Micro Spatula | 104 | Scissors | 29-31 |
| <i>Lister</i> | 31 | Spears, absorption | 157 | Serrations | 31 |
| <i>Mayo</i> | 34 | Spectacles Headband | 168 | ToughCut | 30 |
| <i>Mayo-Noble</i> | 35 | Spectacles, magnifier | 166-169 | Tungsten Carbide | 30 |
| <i>Mayo-Stille</i> | 35 | Spencer Ligature | 26 | Staplers, skin | 120-121 |
| <i>Metzenbaum</i> | 32-33 | Spinal Cord Hook | 99 | Sterilizers, hot bead | 149 |
| Mini Lister | 31 | Spoons | | Sterilizing containers | 152-153 |
| Moria | 5, 7, 11, 18 | Mini Perforated Spoon | 108 | Sterilizing mats | 151 |
| <i>Shea</i> | 25 | Mirror Finish Cutting Spoon | 108 | Sterilizing pouches | 148 |
| Spencer Ligature | 26 | Moria Spoon | 108 | Sterilizing wraps | 152 |
| Spring | 3-14 | Perforated Spoon | 108 | <i>Stevens</i> tenotomy scissors | 24 |
| Standard Pattern | 29 | Spring scissors | | Strabismus | 23 |
| <i>Stevens</i> Tenotomy | 24 | Angled | 3, 4, 5, 8-9, 12-13 | Student | |
| <i>Strabismus</i> | 23 | Ball Tipped | 8 | Bone Scissors | 174 |

- Dumont forceps..... 176
 Forceps 175-177
 Hemostatic forceps..... 178
 Instruments, About..... 183
 Lister..... 174
 Needle holder..... 178
 Pin holder..... 179
 Retractor 179
 Scalpel handle..... 179
 Scissors 173-174
 Spring scissors, *Vannas*..... 173
 SuperGrip forceps 75
 Surgical scissors..... 29-35
 Left-handed..... 29
 Surgery plate 129
 Suture
 Clips, AutoClip..... 121
 Clips, *Michel*..... 118
 Needles 116-117
 Nylon 117
 S&T micro needles and suture 116-117
*Suturing Principles and Techniques in
 Laboratory Animals, Manual and DVD*.... 119
 Thread 116-117
 Tying forceps..... 76-77
- T**
 Tags, Ear..... 143
 Tape
 Identification..... 146
 Sterilization..... 150
 Ruler Label 164
 Tattoo system..... 143
Taylor forceps 91
 Timers 165
 Tip protectors 147
 Tip Replacement..... 87
 Tissue
 Pick 99
 Scissors 27
 Titanium
 About..... 183
 Artery clamp..... 133
 Ceramic 10
 Forceps 65, 69, 80, 86, 90
 Scissors 5
 Serrefines..... 132
 Vascular Clamps..... 130, 132
- Tools..... 160-161
 ToughCut
 About..... 183
 Bonn-Strabismus 15
 LaGrange 25
 Mayo..... 34
 Metzenbaum 33
 Scissors 6, 15, 20, 25, 30, 33-34
 Spring scissors..... 6
 Scissors with tungsten carbide..... 21
 Standard Pattern..... 30
 Trephines 159
 Trident II spring scissors 12
 Tungsten needles, etched 107
 Tungsten carbide
 About..... 183
 Forceps 84
 Mayo..... 34
 Metzenbaum Fino 32
 Needle holders..... 111-115
 Noyes..... 9
 Scissors 9, 20-21, 23, 30-32, 34, 44
 Scissors with ToughCut..... 21
 Standard Pattern..... 30
 Strabismus 23
 Tweezers, Dumont..... 41, 63-72, 139
- U**
 Ultra Fine Clipper Scissors II..... 14
 Ultra Fine Hemostat 92
 Utility scissors 161
- V**
Vannas spring scissors 3-7, 173
Vannas-Miniature spring scissors..... 5
Vannas-Tubingen spring scissors..... 4
Vannas-Wolff spring scissors 7
 Vascular clamps..... 130, 132-133
 Vernier caliper..... 163
 Vessel cannulation aids 136-139
 Vessel cauterizer 156
 Vessel dilating probe..... 103
 Vessel dilators 103, 136-137
 Vessel spring scissors 14
 Vetro grasping forceps..... 78
 Vial forceps..... 78
 Vitrectomy scissors 13
 V-Hook..... 135
- Von Graefe* knife 50
- W**
 Wagner 19
 Walton 24
 Wax 48
Wecker spring scissors 11
Weitlaner-Locktite retractor 128
Westcott spring scissors 10
 Wire contacts, gold..... 165
 Wire teeth retractor 125
 Wound Clousure 109-121
 Wraps, sterilization 152
Wullstein retractor 128

Allgemeine Information der Fine Science Tools GmbH

Sämtliche unserer europäischen Lieferanten und Hersteller sind ISO 9001 zertifiziert. Die Produkte der FST GmbH sind ausschließlich für den veterinärmedizinischen Gebrauch beziehungsweise zu Forschungszwecken bestimmt. Sie werden nicht für den Einsatz im humanmedizinischen Bereich verkauft. Die meisten Instrumentenbilder im Katalog sind in Originalgröße abgebildet. Da es sich um handgefertigte Produkte handelt können die tatsächlichen Maße von den Angaben im Katalog abweichen.

PREISE: Die in diesem Katalog aufgeführten Preise verstehen sich in europäischer Währung (EURO), zzgl. der gesetzlich gültigen Umsatzsteuer. Sie gelten vom 01. November 2017 bis 31. Oktober 2018. Preisänderungen behalten wir uns vor.

GARANTIE: Wir garantieren, dass sämtliche chirurgische Instrumente frei von Material- und Verarbeitungsfehlern sind. Die vorbehaltlose Rücknahme von Ware bei Nichtgefallen gehört zu unserem Service. Wir leisten umgehend Ersatz durch Umtausch der Ware oder Rückerstattung des Warenkaufpreises.

BEANSTANDUNGEN: Falls Sie eine Sendung in beschädigtem Zustand erhalten, informieren Sie uns bitte umgehend. Benutzen Sie in diesem Falle für die Rücksendung die Originalverpackung.

REPARATUR & RÜCKLIEFERUNGEN: Ein Reparaturservice im eigenen Haus für sämtliche mikrochirurgischen Instrumente steht unseren Kunden ebenfalls zur Verfügung. Bitte fragen Sie hierfür nach unseren Preisen. Bei Rücklieferungen achten Sie bitte auf ausreichend sichere Verpackung und legen der Sendung eine Auftragsreferenz (Lieferscheinkopie o.ä.) sowie eine Begleitnotiz mit der Schilderung des aufgetretenen Problems bei. Bereits benutzte Instrumente müssen absolut sauber und frei von biologischen, chemischen und anderen Verunreinigungen sein.

SONDERARTIKEL: Sonderanfertigungen sowie nicht im Katalog aufgeführte Artikel bedürfen schriftlicher Bestellung/Bestätigung und sind generell vom Umtausch ausgeschlossen.

General Information of Fine Science Tools GmbH

Unless all of our manufacturers and suppliers are ISO 9001 certified, FST products are not meant for use on humans. Products offered by FST are sold with the understanding that they are used by qualified persons in veterinary, research and experimental procedures only. Most of our surgical instrument images in the catalog are shown in actual size. As these instruments are handcrafted, in rare cases dimensions vary slightly from those stated in this catalog.

PRICES: Prices stated in this catalog are in European currency (EURO), before applicable sales tax. Prices are subject to change without notice. They are valid November 1st, 2017 to October 31st 2018.

GUARANTEE: We guarantee unconditionally our surgical instruments to be free from manufacturing defects. If you are not entirely satisfied with the purchase, you may return the items, and we will replace it, or your money will be refunded full.

COMPLAINTS: In case you found the shipment to be damaged upon receipt, please notify us immediately! In that case, please use the original packing for return shipment.

REPAIR & RETURN SHIPMENTS: We also offer an in house sharpening service for all kinds of microsurgical instruments. Please call for pricing. When returning goods, please be sure to use proper packing, enclose an order reference and a written description of problem incurred. If the instruments have been used, please be ensure that they are absolutely clean and any biological, chemical or other contaminants have been removed before returning them.

SPECIAL ORDER ITEMS: Special makes as well as articles not offered in our catalog must be ordered/confirmed in writing. They can not be returned.

THE INFORMATION IN THIS CATALOG IS ACCURATE TO THE BEST OF OUR KNOWLEDGE. DESIGNS, STYLES AND DIMENSIONS DEPICTED IN THIS CATALOG ARE SUBJECT TO CHANGE WITHOUT NOTICE. ALL RECOMMENDATIONS OR SUGGESTIONS ARE MADE WITHOUT GUARANTEE, AND WE DISCLAIM ANY LIABILITY INCURRED IN CONNECTION WITH ANY RECOMMENDATION. WITH THE PURCHASE OF ANY PRODUCT FROM THIS CATALOG THE USER ASSUMES ALL RISKS AND LIABILITIES WHATSOEVER IN THE USE OF SUCH PRODUCTS. NEITHER SELLER NOR MANUFACTURER SHALL BE LIABLE IN TORT OR CONTRACT FOR ANY LOSS OR DAMAGE (DIRECT, INCIDENTAL, OR CONSEQUENTIAL) ARISING OUT OF THE USE, MISUSE, OR INABILITY TO USE SUCH PRODUCT.

FST IS A REGISTERED TRADEMARK OF FINE SCIENCE TOOLS INC. FINE SCIENCE TOOLS, TOUGH CUT, CERAMA CUT, AND FINE SURGICAL INSTRUMENTS FOR RESEARCH ARE TRADEMARKS OF FINE SCIENCE TOOLS INC. FST, TOUGH CUT, AND CERAMA CUT ARE REGISTERED TRADEMARKS OF FINE SCIENCE TOOLS (USA) INC. FINE SCIENCE TOOLS AND FINE SURGICAL INSTRUMENTS FOR RESEARCH ARE TRADEMARKS OF FINE SCIENCE TOOLS (USA) INC. FINE SCIENCE TOOLS AND FST ARE REGISTERED TRADEMARKS OF FINE SCIENCE TOOLS GMBH.

© COPYRIGHT 2017 THE TEXT, PHOTOS AND DRAWINGS CONTAINED IN THIS CATALOG ARE PROPRIETARY TO FINE SCIENCE TOOLS INC. AND MAY ONLY BE COPIED, DUPLICATED OR OTHERWISE REPRODUCED WITH THE WRITTEN CONSENT OF FINE SCIENCE TOOLS INC.

Dieser Katalog bleibt unser ausschließliches Eigentum.

Es gelten unsere **Allgemeinen Geschäftsbedingungen (AGB)**, welche unter www.finescience.de einsehbar sind.

Nachdruck, auch auszugsweise, ist verboten. Wir behalten uns vor, Änderungen und Verbesserungen durchzuführen und die Instrumente ohne besonderen Hinweis in der modifizierten Ausführung auszuliefern.

This catalog remains our exclusive property.

Our **General Terms and Conditions** may be found on our Homepage www.finescience.de.

Reprinting, even partially, is prohibited. We reserve the right of technical modifications and improvements and to supply the instruments without specific indication in the modified version.



Scissors, Bone Instruments
& Scalpels
pages 3–61



Forceps & Hemostats
pages 63–97



Probes, Needle Holders,
Thread, Retractors & Clamps
pages 99–139



Surgical & Laboratory
Accessories
pages 141–171



Student Quality Instruments
pages 173–179

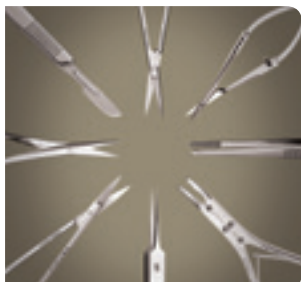

Reference Pages
pages 181–200



INTERNATIONAL

Fine Science Tools Inc.

410-197 Forester Street
North Vancouver, British Columbia
Canada V7H 0A6

Telephone 800-665-5355 / 604-980-2481

Fax 800-665-4544 / 604-987-3299

E-Mail canada@finescience.com

Web finescience.ca



Fine Science Tools (USA) Inc.

373-G Vintage Park Drive
Foster City, California 94404-1139

Telephone 800-521-2109 / 650-349-1636

Fax 800-523-2109 / 650-349-3729

E-Mail info@finescience.com

Web finescience.com



Fine Science Tools GmbH

Vangerowstraße 14
69115 Heidelberg
Germany

Telephone +49 (0) 62 21 - 90 50 50

Fax +49 (0) 62 21 - 90 50 590

E-Mail europe@finescience.de

Web finescience.de



InterFocus Ltd.

Pentagon Business Park
Cambridge Road
Linton, Cambridge
CB21 4NN
United Kingdom

Telephone +44 (0)1223 894833

Fax +44 (0)1223 894235

E-Mail sales@surgicaltools.co.uk

Web surgicaltools.co.uk



Muromachi Kikai Co., Ltd.

4-2-1, Nihonbashi-Muromachi
Chuo-ku
Tokyo 103-0022
Japan

Telephone (03) 3241-2444

Fax (03) 3241-2940

E-Mail fst@muromachi.com

Web muromachi.com



Proserv Instruments Co., Ltd.

7F-2, No. 413
Hsin-Yi Road, Sec. 4
Taipei, Taiwan
R.O.C.

Telephone (02) 27230455

Fax (02) 27230799

E-Mail proserv@ms14.hinet.net

Web proserv.com.tw